

TRIUMF



ANNUAL REPORT SCIENTIFIC ACTIVITIES 1997

CANADA'S NATIONAL MESON FACILITY
OPERATED AS A JOINT VENTURE BY:

UNIVERSITY OF ALBERTA
SIMON FRASER UNIVERSITY
UNIVERSITY OF VICTORIA
UNIVERSITY OF BRITISH COLUMBIA

ASSOCIATE MEMBERS:

UNIVERSITY OF MANITOBA
UNIVERSITÉ DE MONTRÉAL
UNIVERSITY OF REGINA
UNIVERSITY OF TORONTO

UNDER A CONTRIBUTION FROM THE
NATIONAL RESEARCH COUNCIL OF CANADA

APRIL 1998

The contributions on individual experiments in this report are outlines intended to demonstrate the extent of scientific activity at TRIUMF during the past year. The outlines are not publications and often contain preliminary results not intended, or not yet ready, for publication. Material from these reports should not be reproduced or quoted without permission from the authors.

ISAC PROJECT

INTRODUCTION

For ISAC, 1997 was a year of expectation and transition. The technical groups responsible for installing the proton beam line components, the target station, the low energy beam transport, the off-line ion source and the RFQ linear accelerator were eagerly awaiting the completion of various parts of the building. In particular, the accelerator hall and the beam line 2A tunnel were scheduled to be complete by April and August, respectively. However, completion of the buildings was delayed, primarily due to an unusually wet winter season. This delay, in turn, postponed the start of installation of the off-line ion source to late July and the beam line 2A tunnel components to October. Although initially both technical and construction crews attempted to work side by side, the level of cleanliness required by the technical facilities was impossible to maintain. Even by year end it is obvious that a great deal of effort is still required to make the transition from a 'completed' building to a useful laboratory. In spite of the frustrations, with regards to maintaining the schedule, the achievements and changes are truly impressive. In the end the civil construction was 'completed' only 2 months later than that predicted by the accelerated schedule which had been drawn up in the fall of 1995! Beam was successfully extracted from the cyclotron onto a temporary dump in the vault section of beam line 2A ahead of schedule. The RFQ task force, working inside a temporary enclosure, extracted beam from the off-line ion source early in November, on schedule, and confirmed the calculated resonant frequency of the shortened RFQ just before the Christmas break. These milestones were achieved in spite of the fact that TRIUMF was unable to fully provide either the projected personnel requirements or the projected budget. Moreover, cash flow projections were adversely affected mid way during the fiscal year when it was decided to advance the low energy beam milestone date by several months without increasing the cash flow. The uncertainty with regards to the timely disposal of the Chalk River separator magnet made it necessary to devote considerable effort into crafting an alternate approach. Resource management under these constraints was challenging. Nevertheless, TRIUMF personnel responded positively to the challenge and significant progress has been realized in many areas. Detailed reports of the ISAC activities can be found in the following sections.

SCHEDULE AND PLANNING

The Planning group was actively involved in planning, scheduling, coordinating and expediting several

sub-projects for ISAC. Plans and PERTs were prepared, manpower estimated and analyzed, and PERTs were updated regularly. The main activity was the design of ISAC sub-projects and procurement of components especially for 2A, target areas, RFQ, off-line source, ISAC test stand and mass separator. Approximately 83% of total available Design Office effort was spent on ISAC, which is the equivalent of 10 full-time designers. In addition, significant design support was provided by the Univ. of Victoria and some TRIUMF groups (Remote Handling, RF, and Cryogenic Targets) to meet the schedules. Also, 65.3% of total Machine Shop effort was spent on ISAC. The highlights and major milestones for various sub-projects are as follows:

2A extraction probe and beam line 2A

The 2A extraction probe and front-end of beam line were tested with a temporary dump at 1–10 nA and at energy of up to 510 MeV in the spring shutdown (March 21–May 22).

The assembly of 4Q 8.5/8.5 quads started at TRIUMF in March, and up to 14 quads were assembled and mapped by October. All dipoles and steering magnets were received in September/October, and field mapped by November/December, to prepare for installation.

The aim is to commission beam line 2A with proton beam to the dump module by June, 1998.

Target areas

Work breakdown structure led to dividing each of 5 modules (to be housed in a large T-shaped vacuum tank) into several major components, which included service caps, service ducts, shield plugs, containment boxes, diagnostics, and complex services. The plan is to install entrance and dump modules by May, 1998, target and exit modules by June, 1998, with an aim to get a stable beam out of the exit module at the Faraday cup by July, 1998.

RFQ and RFQ task force activities

An 8 m long RFQ tank was designed and procured in September, and then installed on a concrete pad in the ISAC building in October/November.

Ring components, which included base plate, stems, strong backs, outer and inner skins, electrode supports and electrodes, were designed, manufactured and assembled to tight tolerances by November. After installing and aligning the platens, 7 rings were installed and aligned in the tank in November/December, followed by an installation of rf shroud and rf bulkhead, and the resonant frequency was measured at 36.1 MHz. Most of the design for all 19 rings

and fabrication of some components was completed in 1997.

Off-line ion source (OLIS) and LEBT

The installation of the off-line source was delayed to September, 1997, due to delays in building construction. However, a major portion for commissioning the source was installed in October. Vacuum and microwave power in the source was achieved (October 31), beam to Faraday cup 3 (November 7), and beam through the bender up to Faraday cup 6 (December 12).

Mass separator

A mass separator system was received from Chalk River in August. A pre-separator magnet was designed and sent out for bids in December. The design for pre-separator diagnostics and services started in October.

Drift tube linac (DTL)

After prototyping critical components, detail design for the first tank, including stems, ridges and end-plates was completed and sent out for bids in December. The design and fabrication of the DTL buncher was sub-contracted to INR-Troitsk with an aim to receive the buncher in April, 1998.

Manpower

Manpower estimates for all sub-projects were compiled, which showed very high peaks of manpower requirements for the year and for early 1998. Priorities were evaluated, and highest priority was assigned to meet the goal of delivering radioactive beam to TRINAT by October 31, 1998, which requires finishing 2A, target areas, separator system, and TRINAT. The resource leveling was done and schedules were revised to reflect this priority.

CONVENTIONAL FACILITIES

1997 was the year that saw ISAC constructed. Although excavation started in the fall of 1996, record rainfalls caused work delays that were never to be recovered.

Once out of the mud, concrete work proceeded with a focus to the north half of the building so as to allow completion of the experimental hall at the earliest date. During the months of March, April and May the building started to take shape with the structural steel, exterior cladding and roof deck. Erection of the 35 ton crane in the experimental hall occurred in May followed by the slabs-on-grade. During May, June and July the target maintenance building rose above ground with the erection of the steel. The *future*, but unfinished floor was incorporated into the building during the construction, adding an additional 3,540 ft² of potential office space.

May also saw the start of the finishing trades on site and by August several of the earlier trades were reaching the substantial completion stage of their contracts. In July TRIUMF personnel started the process of occupying the areas of the experimental hall for the purposes of equipment installation. The lateness of the structure due to the early rains resulted in these areas being far from the ideal occupancy conditions anticipated and the physicists quickly learned the ins and outs of working within a construction site. Hard hats were the norm throughout TRIUMF.

By mid-August the building envelope was generally complete and the process of tying in the mechanical and electrical services was well advanced. The long-awaited paving of the area surrounding ISAC finally took place during the first week of November and the cleaning up of the dust could be done once and for all. By Christmas most trades were in the deficiency stages of their work and testing and commissioning of systems were in progress.

Since August, TRIUMF employees have been working on installation of technical aspects with bulk concrete work in the target hall, installation of BL2A and OLIS installation. Final inspections are expected to be carried out in early February, 1998 for formal occupancy.

Technical infrastructures

Many activities were completed during this extremely busy year. Logistics work included the coordination with the conventional buildings to incorporate the changes requested by the TRIUMF users, and with the accelerator systems and the experimental facilities for the layout of systems and equipment in the experimental hall. The general arrangement and equipment layout drawings of the experimental hall were developed and maintained. The layout of the electric room required several iterations to accommodate both the power distribution and the services and control racks for beam line 2A and 60 kV Faraday cage/target station systems. The mass separator support room required special attention to develop a layout that would retain a sufficient amount of the initial service functions even with the addition of the TRINAT laboratory.

Electrical services

The beam line 2A racks and cable tray systems to the vault and the ISAC tunnel, the ac power distribution and dc cabling to the vault section were housed on the northeast corner of the cyclotron vault roof. Modifications to the east shielding of the vault were required for the routing of the services to the vault

side of the beam line. To eliminate the need for an additional power distribution centre, loads were rearranged in the proton hall power centres MCC-G and MCC-Q to free up power for beam line 2A. DC cables to the tunnel were strung. The part of the beam line in the tunnel was galvanically decoupled from the electrical ground of the cyclotron to facilitate the ground referencing of the controls and diagnostics signals installed in the electric room. The ac power distribution to the racks in the electric room was detailed and is ready for installation early in 1998.

The main 5 MVA, 12.5 kV power feeder installation was completed early in August after a few weeks delay caused by cable damage during shipment to TRIUMF. The cable was replaced at no cost to TRIUMF. The ISAC main power system and all four 1000 kVA power distribution centres were energized on August 11. The power factor correction system was specified. Installation is planned for 1998.

The services to OLIS/LEBT in the experimental hall and the 60 kV distribution in the Faraday cage and control racks were commissioned in October. Particular attention was paid to the grounding of the racks and the 60 kV Faraday cage to minimize problems associated with electrical noise. The design of the power distribution for the services for the RFQ system was completed in December. The rf amplifier breaker was installed and power was connected in November. It is planned to install the power distribution and the remainder of the services for rf controls, vacuum and roughing systems early in 1998. The initial rf grounding design was modified based on the change of the frequency of the DTL to 105 MHz. Two dedicated grounding stations are presently installed in the experimental hall, one for the RFQ and one for the DTL. The power distribution in the mass separator service annex has been increased to 300 kVA to service the need of the relocated TRINAT laboratory. The mass separator single point ground was simplified. The ground plan will be run on the floor along the beam line to the target station and along the 60 kV transmission live to the ion source Faraday cages and controls.

Mechanical services

The mechanical installations contracted by Lockerbie and Hole were largely completed. At year-end the drainage systems, heating, fire sprinklers, domestic hot and cold water, cooling tower, non-active low conductivity water and compressed air systems were all operating. The other mechanical systems (non-active and active exhaust, air conditioning, and low active low conductivity water) are completed mechanically but have not been started up. The DDC control system was not completed and therefore the instrumentation and system controls were not functioning. Thus, although

operating, the above systems were uncontrolled. Commissioning and start-up were proceeding and no systems have yet been signed over as accepted to TRIUMF. The 35 ton crane in the experimental hall has been accepted by TRIUMF. The design for the high active LCW system was completed and drawings prepared by the Design Office. Connections to cooling water services were made for the off-line ion source system, the RFQ amplifier and the magnets in the 2A beam line tunnel.

Data and voice communication services

Early in 1997 information was gathered from a series of sessions with ISAC users and planners. As a result several proposals were submitted to the ISAC committee meetings which developed into a network design. All the cabling and interconnection concepts were specified, estimated and budgeted for all individual data connection in ISAC as well as the main fibreoptic feeds to the building. Budget restraints allowed the purchase only of a portion of the required workstations, fibre cable and terminal and patch panel hardware. We chose to incorporate both the planned Internet upgrade and the future ISAC network into one environment to reduce costs and to introduce us to the new technology as required. A Fore Systems Power Hub was chosen for the backbone hub to supply the new network needs. The new hub was purchased to integrate TRIUMF's existing network to the new Internet connection and to provide start-up services to ISAC. The equipment is being tested and configured. It will be installed in the main office building early next year to provide the Internet upgrade connection. The plan is to move the backbone hub and additional components from the main office building to the ISAC computer rooms.

SCIENTIFIC PROGRAM AT ISAC

ISAC science – initial program

To define the initial scientific program of ISAC, a multistage process was put in place: letters of intent were solicited and reviewed by the Experiments Evaluation Committees (EEC) in December, 1996.

A Workshop on Experiments and Equipment at Isotope Separators (WEEIS) [eds. L. Buchmann, J. D'Auria, TRIUMF Publications Office report] was held April 26–29, 1997 to help develop the proposals which were reviewed by an ISAC panel of experts in July, 1997. The composition of the panel is given in the appendix and a list of approved proposals can be obtained from the Science Division office.

At the December, 1997 meeting of the EEC, two more proposals and a letter of intent were considered.

Final prioritization and beam time allocations were deferred until the next panel meeting in June, 1998.

ISAC experimental facilities

Through a series of meetings during the year, a layout of the experimental area has been developed which satisfies the requirements of the initial experimental program of ISAC (as reviewed by a special ISAC panel and the Experiments Evaluation Committee last July).

Figure 103 gives the current layout for the low energy experimental area which is being detailed for

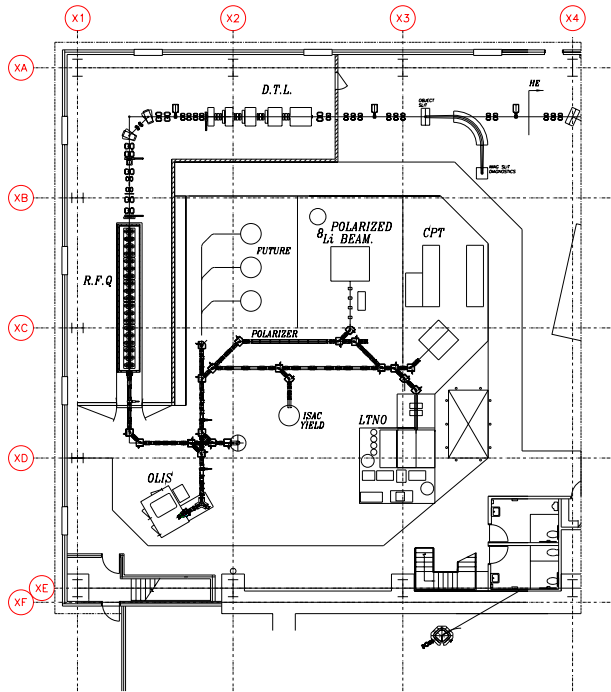

Fig. 103. Possible layout of various experiments in low energy part of the ISAC experimental hall.

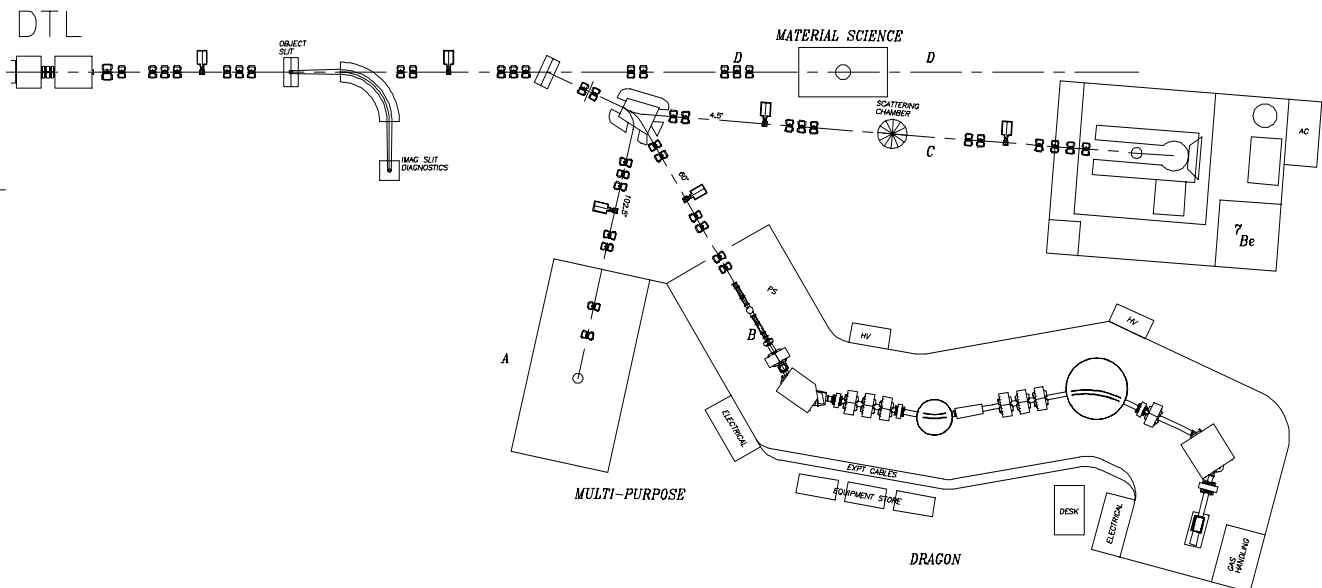

Fig. 104. Schematic of the ISAC high energy area.

budgeting and systems integration. The high energy experimental area is shown in Fig. 104. Many contributed to this effort and the ISAC facility team and experimenters worked well together to achieve it.

While experimenters are now asked to work out the details of their experimental set-up, the ISAC team will take care of the beam transport systems. The layout provides for an intermediate shielded location for the neutral atom traps experiments (TRINAT program), a location in the low energy area for a general purpose station, a low temperature nuclear orientation set-up (to be obtained from Oak Ridge), and a polarizer section to service the condensed matter program initially with ^8Li beams. Further expansions are possible to accommodate a Penning trap or other set-ups.

In the high energy area, the main focus will be the nuclear astrophysics spectrometer (DRAGON) and one general purpose station initially.

Considerations towards higher energies in the future have been folded in the plan.

TARGET MAINTENANCE BUILDING, SHIELDING AND ENGINEERING

Work in 1996 had been devoted to investigating and optimizing the layout of the target maintenance building (TMB). This resulted in reducing the office area footprint and increasing the height to two floors above grade.

The target hall configuration was based on the remote handling philosophy that had been adopted, which was to use the hall itself as radiation shielding during module transport rather than a more conventional transport flask.

Hence, 1997 concentrated on the detail design of the adopted concepts. The major engineering challenge reported in this section is the detail design of the target hall, while the more conventional office area detail engineering was dealt to consultants. A report on these activities can be found in the Conventional Facilities section.

Target hall

The target hall runs east-west and is 137 ft. long, 18 ft. wide and 45 ft. in height from the floor of the storage pit (which is at level 264 ft.). Contents of the hall east to west are as follows: an assembly work area with hatchway and doorway which will be the only opening into the target hall. (The construction hatchway in the roof at the west end of the hall will be closed and not normally used.) The roof of the two adjacent hot cells is next, which have openings to accept any of the 5 different modules, such that they are hung from the opening frame into the hot cell; the next area west is the stor-

age pit which is a 38 ft. × 18 ft. area with its floor at level 264. This area is designed to hold moveable storage silos and stackable shielding for future storage of radioactive modules and components; farther west is a landing area 15 ft. × 18 ft. for shield block storage when uncovering either target station; and from here to the west wall is the target area comprising the east and west target station. The arrangement of the target stations within the hall is as shown in Fig. 105. The entire hall is serviced by a special 20 ton crane, which runs the entire length of the hall, augmented by a special 5 ton crane attached to the west beam which allows crane coverage close to the wall.

Target stations

The most significant engineering challenge in the target hall has been the design of the target stations which commenced in late 1996. Briefly, each station comprises a large T-shaped vacuum tank surrounding 5 similar modules, see Fig. 106 (the entrance, target,

TARGET HALL WEST

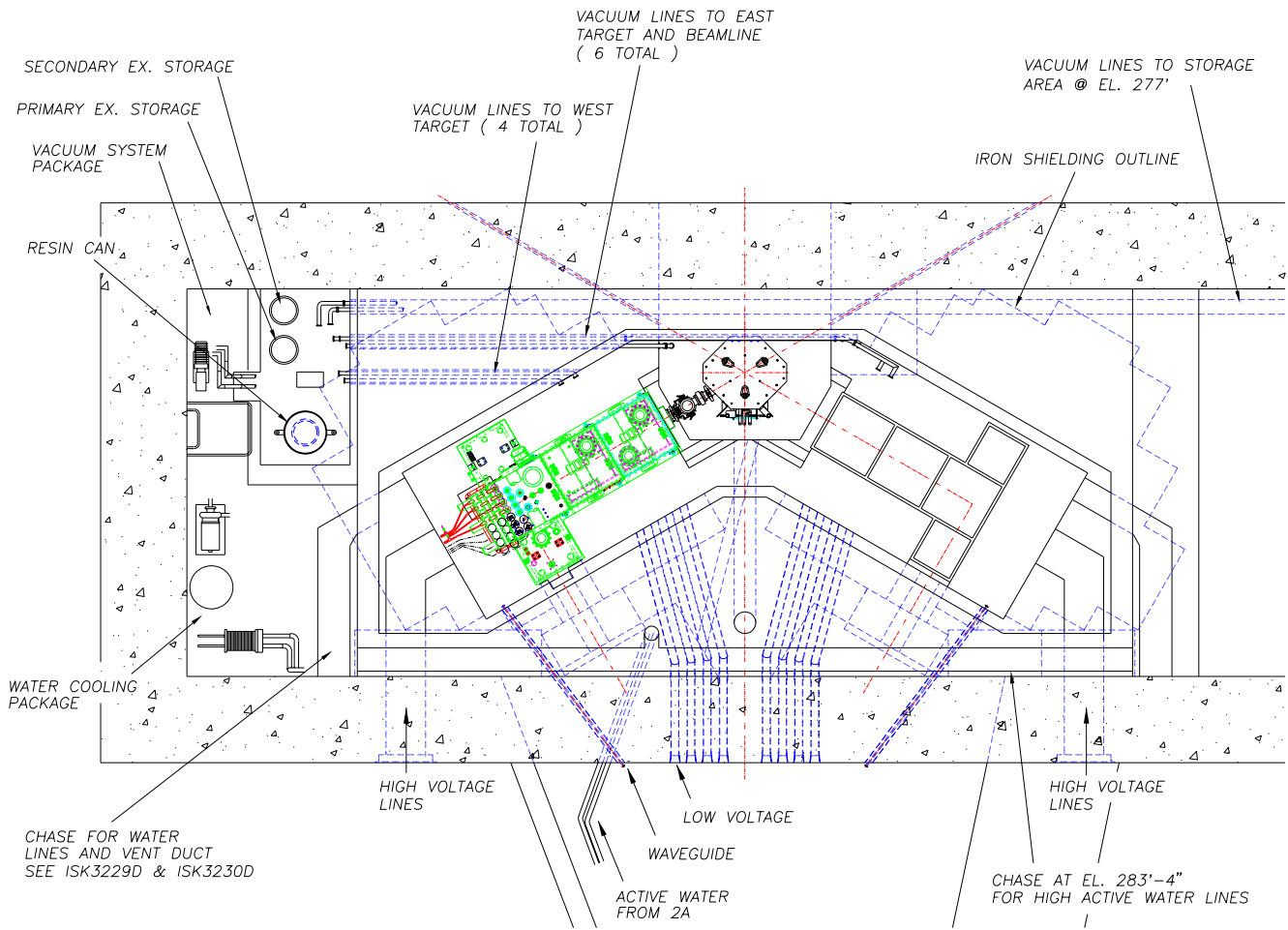

Fig. 105. Arrangement of target stations within the target hall.

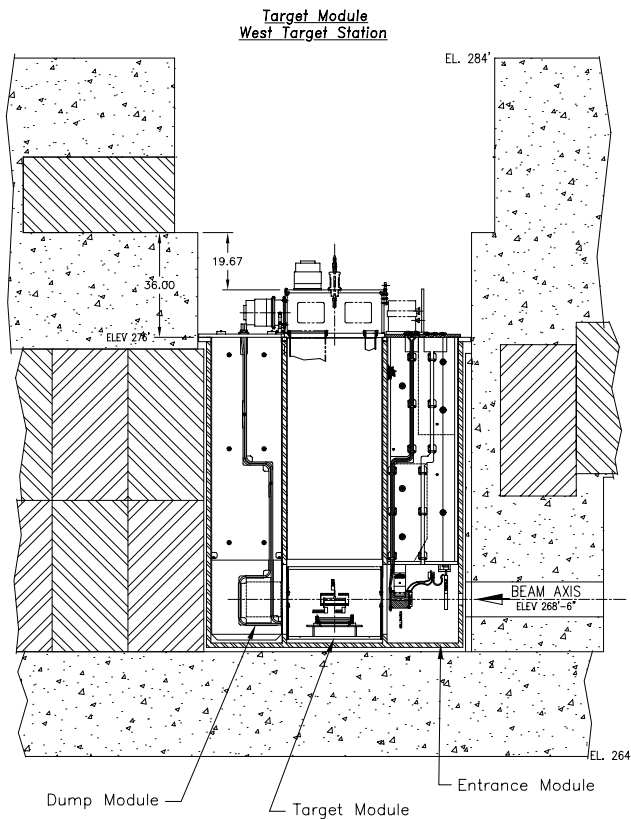

Fig. 106. Target station. Vertical section through proton beam.

dump and exit modules). Of special note is the design of the target module due to its complexity. The target and extraction lenses are housed in a containment box at the bottom of the module. All services to this box run through special ducting from the top service cap; hence the duct must transport 60 kV high current conductors, cooling water, a microwave conductor, diagnostics, and vacuum through 7 ft. of shield plug, without seriously compromising the shielding function. The containment box is pumped by the primary vacuum system TMPs (turbo molecular pumps) while outside the containment box, and throughout the vacuum tank, vacuum is maintained by the secondary vacuum system TMPs. The 2 exit modules have a similar arrangement and all 3 containment boxes are linked via an intermodular connector during operation such that the primary and secondary systems are separate. When modular servicing is required, services are disconnected, the vacuum tank vented, intermodular connector withdrawn, and a module removed remotely. The entrance module supports proton beam diagnostics, the dump module houses the proton beam water cooled dump, and the exit modules house RIB optics and diagnostics prior to entering the pre-separator magnet.

Each target station vacuum tank is housed in a

pit and covered with shield blocks. Services are transported to/from each station through special chases and ducts, and penetrations from various sources, i.e., the high voltage chase houses 9 pairs of high voltage conductors from the high voltage power supply in the adjacent electrical service room.

Facility conceptual drawings were delivered to the mechanical consultants starting in May, and work in the west end of the hall around the target stations commenced upon arrival of the steel shield blocks in August. Target station detail drawings began to emerge in early summer, and continued until the end of the year.

Shielding

Much of the configuration described above resulted from extensive investigations into shielding. Adjacent work areas in the TMB and in the TRINAT level of the experimental hall required that radiation levels be below $10 \mu\text{Sv}/\text{hour}$, hence the amount of steel and concrete was calculated and the configuration adjusted accordingly using Moyer model analysis. The design was completed early in the year and utilized special 10 ton steel shield blocks, 45 blocks per station. These were positioned in such a way as to form 2 pits for the 2 vacuum tanks. They were then encased in concrete. This is done over 5 separate concrete pours. Each layer coinciding with the different requirements, at that level. Pour 3 was completed during the year (level 275 ft. 3 in.) with 2 more pours required in early 1998, to bring the level to 284 ft. Each target station pit is completed by the insertion of separate concrete blocks. This allows future accessibility to some key components. Radiation emanating vertically from the target is controlled by the 7 ft. steel shield plug contained in each module, allowing for the use of elastomers at the service cap level. Each target station pit is then covered over by five 5 ft. thick steel and concrete shield plugs controlling radiation into the target hall. These shield plugs, as well as other special removable shield plugs, have been drawn up and their detail design will commence shortly with manufacture to follow in the spring of 1998. Most of these special shield plugs will not be necessary for the early low beam current tests planned for 1998.

Alignment and assembly

An essential element of target design and construction is the critical physical alignment of the beam source, optics, diagnostics, and target ion source components. The target vacuum tank to establish proton/ion beam centre lines w.r.t. module positioning, as well as individual components on the modules, all require precise mechanical alignment. An attainable

method for this alignment measurement, positioning, indexing, confirmation and verifiable alignment transfer was conceived during the year.

Critical alignment must be accomplished during initial installation of the target vacuum tanks and assembly of all individual module components. It will also be imperative to achieve this same precise alignment of components after beam irradiation. Alignment must be performed given the severe limitations imposed by working in a remote handling hot cell facility. A unified strategy was required to accomplish both initial alignment of all components as well as to perform hot cell replacement and repair maintenance, while assuring the same critical alignment.

A program of alignment devices and procedures was developed to perform the necessary alignment tasks.

- An alignment transfer jig to measure the relationship of the target vacuum tank module locations w.r.t. the established proton/ion beam centre lines. This jig is used to transfer the surveyed measurements to other alignment devices and fixtures. It will also serve as an alignment “master” reference. The jig was designed and fabricated during the year.

- A target alignment stand, with provision to reproduce the exact alignment conditions of each of the 10 different target module locations. Discrete intermediary plates will duplicate each target location, as established and confirmed via the alignment transfer jig. Optical alignment telescopes on this stand sight the designated established proton/ion beam centre lines. This stand has now been designed with drawings ready for manufacture.

- A set of 3 module support frames for simultaneous assembly of a full set of 5 target modules at one time. These frames were designed, drawn, fabricated and assembled during the year.

A module assembly area has been cordoned off in the east end of the experimental hall. The module support frames were erected in this area late in the year, and are currently available to commence assembly of the modules. The target alignment stand will also be installed in the area once completed. The 2 target vacuum tanks have been received and are currently being held in this area for cleaning and leak checking prior to installation into the target hall. The roof hatchway in the west end of the target hall has been left open in order to accomplish this.

Remote handling

This year saw the fundamental principles of ISAC remote handling firmly established, design concepts initiated, and shop drawings generated for a few essential components. The detail design of many remote handling components is largely dependent on target designs still under evolution. This phase of the work is

just becoming feasible, as commitment to certain design elements at too early a stage could compromise future handling options.

The original philosophy for remote handling at ISAC remains basically unchanged. A travelling overhead crane operating within the heavily shielded and air-zone contained target hall provides multiple handling functions. Personnel working in the hall will use the crane in “local” pendant mode to remove and reposition necessary shielding, while manually disconnecting all target services. Operated from outside the target hall by a remote control system, the crane will lift and transport radioactive targets and other components within the hall from one shielded location to another. The target hall will be vacated and “locked-out” for all remote operations. Remote crane handling will service the two east-west target areas, the north-south hot cells, and the module storage pit area between. For routine manual tasks in the hall, the crane also accesses the west mechanical services bay, as well as the assembly area and target hall access hatch to the east. A pair of sealed and shielded conventional hot cells, accessible by the overhead crane, will be equipped to maintain and repair active targets and other components.

The majority of remote handling design effort has gone into collaboration with the targets design, to assure future ease of handling for beam diagnostics, transport and target ion source components on the target, entrance, dump and exit modules. These components are located inside a contamination containment box attached to the bottom of each shielded module plug. The individual components, as well as their unique electrical and cooling services, must be hot cell repairable and replaceable to maintain ISAC ion beam production operation. This work will require positioning of the modules, removal of access panels, disconnection of services, removal and indexed replacement of components, as well as measuring, testing and qualification of systems, with all work performed remotely by a master-slave manipulator in the hot cell.

A pair of 4 ft. thick, 6 ton Pb-glass radiation shielding windows for the hot cells were received. Separate window liner frames, to be installed in the cell walls, were re-designed from the manufacturer’s specification and are being built at TRIUMF. The hot cell layout, including the transport flask system, roof access portal and elevating turn table, were designed in concept. Final design and specification for the manipulators will be determined after an appropriate target mock-up has been performed.

BEAM LINE 2A

In the past years there have been several revisions to the layout of this beam line. The most recent occurred this year with the discovery that the cyclotron

and experimental buildings were not parallel in the east-west direction. The latter had been constructed 2 ft. 7 in. off parallelism with the former. Consequently, a minor revision of the optics of the beam line was required in order that the straight portion of the beam line be perpendicular to the experimental building. In addition, all of the transport components of the beam line were delivered to TRIUMF and their magnetic properties were field mapped. The revision of the optics also included the measured effective length of each element.

The present configuration of the beam line is shown in Fig. 107. Although this figure shows two target locations, only the west target will be installed initially. The east target will be installed in the future to provide beam to experimentalists during repair/replacement of the west target.

Optical revision

Because of the non-parallelism of the cyclotron and experimental buildings it was necessary to alter the configuration of transport elements both within and without the vault. The locations of the quadrupole doublet located upstream of the first vault dipole and the first dipole itself were left the same as in the previous configuration. However, that of the second vault dipole was moved upstream by approximately 2 in. Further, rather than each dipole bending the extracted beam through 27.5° , the deflection angle of the first dipole was reduced to 27.47° and that of the second was increased to 27.56° . Thus minor alteration in the locations of other transport elements was required.

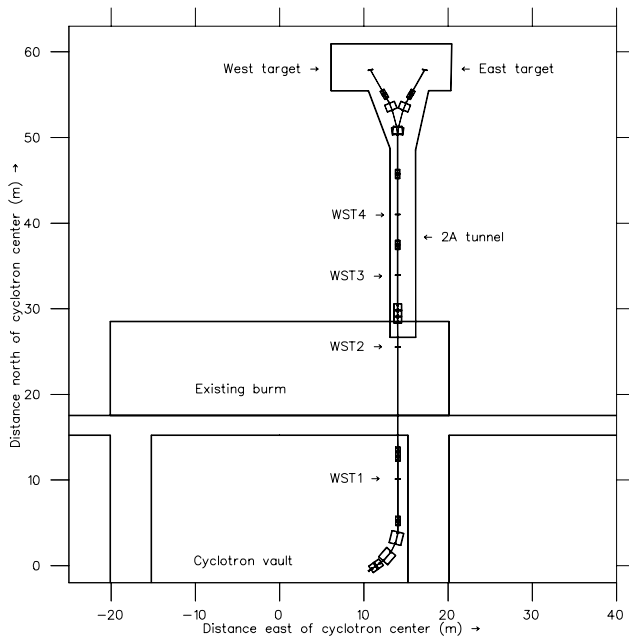

Fig. 107. The configuration of beam line 2A in 1997.

Optics of the beam line otherwise remain the same. The quadrupole doublet located upstream of the first vault dipole and that located downstream of the second vault dipole produce a double waist at the location labelled WST1 in Fig. 107. A quadrupole triplet downstream of the WST1 location produces a second double waist at the WST2 location, approximately 24 ft. beyond the outer vault wall. This waist is reproduced at the WST3 location in the tunnel by a second quadrupole triplet. A subsequent quadrupole doublet produces another double waist at the WST4 location. Beam is directed to the west target by two 15° H-frame dipoles.

As noted above, during the first years of operation only the west target will be operated. Consequently, rather than installing a $\pm 15^\circ$ switching magnet that would direct beam to either target location, two 15° H-frame magnets are used to produce beam at the west target. In the future the upstream dipole will be repositioned in the east leg of the beam line (as indicated in Fig. 107) and a $\pm 15^\circ$ switching magnet will be installed at the location presently occupied by the upstream H-frame dipole.

To produce the required beam size at the west target, a quadrupole doublet upstream of the first 15° dipole and another downstream of the second are used to produce a double waist at the target. There the beam spot is nominally 5 mm in diameter. Because the beam line was intentionally designed not achromatic, the optics are such as to produce a spatially achromatic beam spot at the target. These beam qualities are true for each of the east and west targets.

Installation and commissioning progress

Figure 108 shows the beam line 2A layout. Design and construction of beam line components continued throughout the year.

Of special note was the successful extraction of beam into the front-end section of the beam line during the spring shutdown. The extraction probe, combination magnet and the first two quadrupoles (of the existing 4Q14/8 type) were installed and commissioned. A short section of temporary beam line with three multi-wire monitors and a graphite beam stop were assembled for the purpose of testing the extraction probe and confirming the theoretical beam path. The first step of commissioning was the extraction of beam with the combination magnet removed and replaced by a multi-wire monitor. A scan was done of the extraction probe R and L space to find the 'straight through' energy and to verify the locations of the combination magnet and the exit horn beam port. The combination magnet was subsequently installed and beams were extracted over the energy range 472 MeV to 510 MeV.

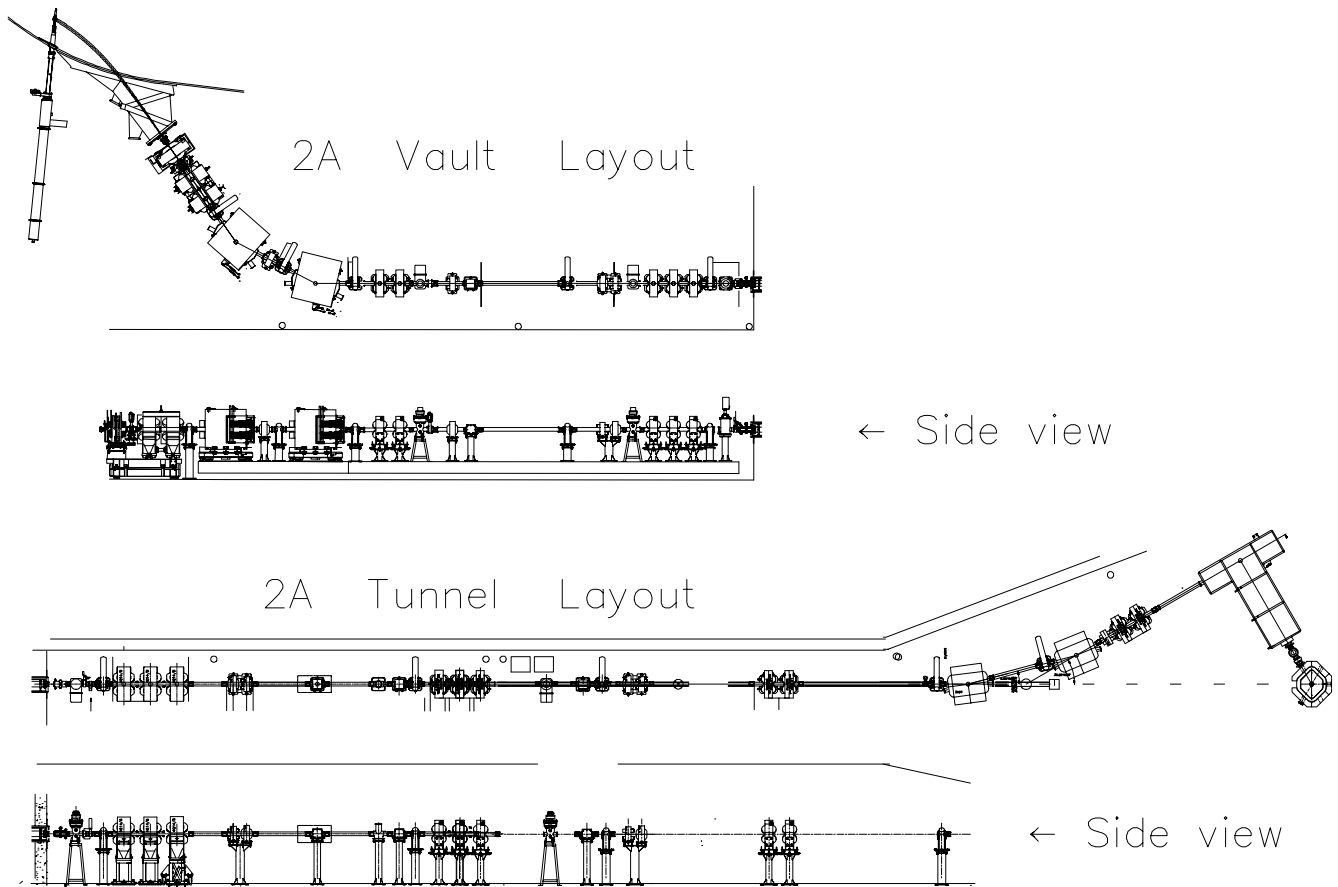

Fig. 108. The layout of beam line 2A.

Most of the vacuum system purchases were made in the 1996/97 fiscal year. Vacuum boxes and stands for the four pump stations were designed and built. Assembly began in December and the pump stations will be installed early in the new year. The vacuum pipe that passes through the 36 ft. long hole through the vault wall to the tunnel entrance was installed during the fall shutdown. Because of cyclotron problems this shutdown was extended three weeks. This extra shutdown time provided the opportunity for vault access to install the stands for some of the vault components.

Installation of components in the tunnel began in October and by the end of the year all quadrupoles and steering magnets in the tunnel upstream of the first 15° dipole (2AB3) were installed and aligned. The remainder of the tunnel-section components will be installed in the new year. Installation of the remaining vault components is scheduled to begin January 26, 1998 with completion in April in time for beam commissioning prior to the start of the next beam schedule which starts May 8, 1998.

Designs for the vault 27.5° dipole magnets 2AVB1 and 2AVB2 and the tunnel 15° dipole magnets 2AB3

and 2A2B4 were completed early in the year and the contracts let. The magnets were delivered to TRIUMF in the fall and have been field mapped. Their stands and vacuum boxes were designed and manufactured and by year end, 2A2B4 was ready for installation. A special cart was designed to transport the 15° dipoles into the beam tunnel.

Assembly of the 4Q8.5/8.5 quadrupoles began in March after the coils and steel sub-assemblies were delivered. Magnets were produced at a rate of about one magnet per week. These were then field mapped and prepared for installation that began in October.

The original TRIUMF steering magnet design was up-dated and a contract let for the manufacture of ten magnets. These were delivered in October.

A new design for beam line profile monitors was completed. This design includes the capability of carrying either a scanning wire or a gas-filled multi-wire ion chamber (MWIC). The MWIC frames have been made using multi-layer PC board technology to simplify assembly and to reduce the number of O-ring seals. Twelve monitors were built. Half of these will have scanning wire heads and the other half will have

MWIC heads. Three of each type will be used in each of the vault and tunnel sections. Eventually, once the beam line tune has been established, some of the MWIC heads may be replaced with scanning wires.

Other non-intercepting monitors and the entrance module diagnostics were designed. A set of pick-up loops with halo plates, designated 2AVM7 and 2AM8, will be installed at each end of the long drift between the vault and the tunnel. Although their vacuum boxes will be installed now, other devices will not be required until the beam intensity is increased above the commissioning levels. Those to be installed later are the 2AM10 diagnostics station, the 2AM11 channel plate, the 2AM12 toroid and the 2AM14 capacitive pick-up. The target station entrance module will contain a retractable profile monitor and a target protect halo monitor that will be mounted on a water-cooled collimator.

ION SOURCE TEST STAND

During 1997, the ion source test stand was successfully commissioned and used for characterization of surface ionization and multicusp plasma ion sources. The surface ionization source was used for initial commissioning.

Test stand commissioning

Beams of singly charged ^{85}Rb and ^{87}Rb were generated by thermal decomposition of Rb_2CO_3 in a small reservoir attached to the prototype ISAC surface ionization source. A multi-electrode extraction column was tuned to provide beam energies ranging from 10 to 50 keV. Beam characterization at locations both before and after the mass separator was accomplished using horizontal and vertical wire scanners for profile measurement, Faraday cups for current measurement and emittance scanners for beam properties. Using only beam steerers, the beam emittance was first measured after the initial matching optics, the object position of the mass separator stage. The deduced ion source divergence was then used to calculate tunes for the matching optics. The ion beam was then centered on the object slit and tuned through the mass separator to the final diagnostic position. In both cases, first order optics calculations gave accurate matches to the desired beam spot sizes at both locations.

Emittance scans of the mass separated beams showed the presence of second and third order aberrations introduced by the dipole magnet. The third order aberrations could be corrected by using an electrostatic octupole just downstream of the bending dipole. Similarly, the second order corrections were made using a sextupole just upstream of the dipole.

Surface ionization source

The prototype ISAC surface ionization source and its fixed geometry multi-electrode extraction column were characterized using the ISAC test stand. Performance as a function of ion beam energy was determined by recording emittance scans of $\sim 1 \mu\text{A}$ ^{85}Rb beams ranging from 10 to 50 keV in energy. At each energy, the beam current was maximized by tuning the extraction column voltages. For the range of beam energies, the brightness (beam intensity divided by the square of the normalized emittance) was remarkably constant, indicating that the fixed multi-electrode extraction column does not appreciably select the extracted phase space.

Emittance measurements as a function of beam current were made for 31.5 keV ^{85}Rb beam currents ranging from 1 to 15 μA in intensity. The measurements indicate no significant intensity dependent effect up to the order of 10 μA .

To determine the suitability of the extraction column for a range of beam masses, emittance measurements were made of mass separated beams of ^7Li , ^{23}Na , ^{39}K , ^{85}Rb and ^{133}Cs . Beam currents of 10–100 nA of the alkalis were extracted simultaneously and emittances were measured changing only the mass analyzing magnet field. The respective emittances were 8.2 ± 0.8 , 9.0 ± 1.0 , 8.4 ± 0.5 , 7.1 ± 0.3 and $7.5 \pm 0.4 \pi$ mm mrad. The marked similarity of emittance values indicates the performance of the source and extraction system is independent of beam mass.

An estimate of the beam energy spread was made by progressively narrowing the object slit of the mass separator section to determine the image width in the limit of vanishing emittance. With a dispersion of 1.25 m, the limiting image FWHM was determined to be 0.16 mm. For a 31.5 keV beam, this represents $\Delta E = 4.0$ eV. It is not known if this arises from high voltage power supply ripple, magnetic field ripple or intrinsic ion source energy spread. Investigations are ongoing.

Multicusp ion source

A 45 degree parallel-plate energy spread analyzer for the ISAC project has been installed on the ion source test stand. Preliminary results were obtained, which agreed with the design goal of an energy resolution of 0.04% and a spectrometer constant of $k=1.29$. By using the analyzer an energy spread of 1.8 eV for a He^{+1} beam from the multicusp ion source was measured. The analyzer is intended for use with future potential ISAC ion sources.

ISAC MASS SEPARATOR

The ISAC mass separator design includes a pre-separator, three matching sections, an acceleration col-

umn, a mass analyzing sector and a deceleration column. The mass separator magnet is located on a high voltage platform in order to have more flexibility in the magnetic field adjustment.

The ion optics was calculated using the computer code GIOS, which can calculate an ion optical system up to the third order. The code now includes an acceleration column.

Pre-separator stage

The pre-separator stage is designed to accept the RIB from either one of the two target stations. The mass dispersion of the pre-separator magnet is 3.7 mm/%, which is adequate for a cleaning stage. The design has the focal plane inside the heavily shielded target vault. By doing so we assure that most of the contamination will remain in the vault. The main parameters of the magnet are listed in Table X. The magnet is being fabricated and we expect delivery of the magnet early in June, 1998.

Mass separation stage

The mass separator magnet used for ISAC was built for Chalk River in the 1970s. This magnet was used until January, 1997 when the Chalk River Laboratory was shut down. The location for this magnet in the TRIUMF separator is shown in Fig. 109.

The resolving power R of the isotope separator is defined by $R = m/\delta m$, where δm is the full width at half maximum of the peak at mass m . For a given object width w and magnification M of the magnet, R is directly proportional to the dispersion of the magnet, D :

$$R = D/(M(w + x_{\text{aber}})).$$

The dispersion is expressed in terms of the displacement

Table X. Parameters of the mass separator system.

Mass range	$6 \leq 238$
Acceleration voltage	$12 \leq V \leq 60$ kV
Beam emittance	
Surface ion source[4]	10π mm mrad
Plasma ion source[5]	30π mm mrad
Pre-separator stage	
Deflection radius ρ_B	500 mm
Deflection angle θ_B	$\pm 60^\circ$
Air gap	70 mm
n	0.0
Mass separation stage	
Deflection radius ρ_B	1000 mm
Deflection angle θ_B	135°
Air gap	100 mm
n	0.5

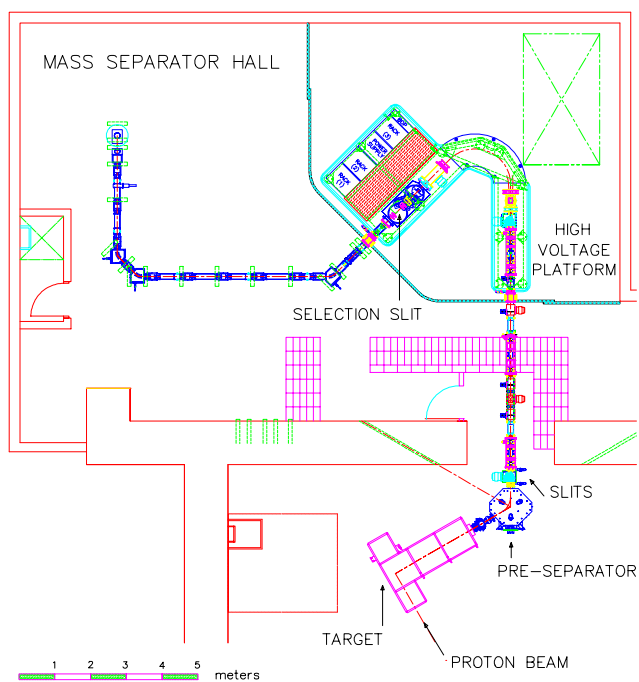

Fig. 109. The ISAC mass separator is composed of two magnetic analysis magnets. The first magnetic bend is mainly used as a cleaning stage. The second bend is installed at high potential and will provide a resolving power $R=10000$ for an initial beam emittance of 10π mm mrad.

ment d in the image plane, taken perpendicular to the beam axis, between ion beam of mass m and $m + \delta m$:

$$D = d(m/\delta m).$$

The magnet was used in an asymmetric configuration. The distance between the object and the magnet entrance is 100 cm and the distance between the magnet exit and the image plane is 164 cm. This leads to an angular magnification of 0.77 and to a dispersion of $D = 2250$ mm. This means that neighbouring beams at mass 100 are separated by 22.5 mm. The entrance face has a concave profile of $R_1 = 35.0$ cm radius of curvature, whereas no exit profile is employed, $R_2 = \infty$. The focal plane is tilted by 26° with respect to the mean beam axis. The maximum operating field is $B\rho_{\text{max}} = 0.625$ Tm. This is sufficient to separate masses up to 238 at 70 keV beam energy. Aberrations into the focal plane of the magnet of the second and third order in both directions were determined using GIOS. The largest aberrations are usually those of second order. For an object that emits particles into an upright rectangle phase-space area the x -aberrations of second order can be expressed; aperture aberration:image aberration:mixed aberration. The aperture aberration is the largest one and we can easily correct it using a curved pole face at the entrance of the magnet.

Diagnostics

The diagnostics required are profile monitors and Faraday cups. Among the several types of profile monitors, a scanning wire will be installed where low resolution is needed. A harp type profile monitor is best suited when the size of the beam is large enough and good positioning is necessary. For very high accuracy the approach will be to combine a harp type monitor with a deflection steerer plate. The beam can be swept across one of the harp's wires. The knowledge of the voltage on the plate and the measurement of the intensity on the wire will yield the beam size. Sensitive Faraday cups are foreseen to assure a good reading of the transmission through the whole separator. An emittance rig will be mounted in the mass separator diagnostic box in order to quantify the size and also verify the applied corrections of aberrations.

Vacuum system

From the ion source to the focal plane of the mass separator the distance is 17.3 m. As mentioned earlier, part of the cross contamination comes from ion scattering on neutral atoms. To avoid beam scattering by residual gas atoms along the path length, good vacuum has to be provided throughout the mass separator. The pressure should be in the lower 1×10^{-7} mbar. For ease of maintenance a series of gate valves will isolate each section from the rest of the mass separator.

The extraction high voltage power supply and the mass separator power supply have to meet the most stringent stability requirements. The uncertainty on the mass m is related to the uncertainty on the magnetic field and the voltage. If we assume a resolving power of 8000, the high voltage power and the magnet power supplies will require an overall stability, ripple, and drift, of better than 1.25×10^{-5} and 6.25×10^{-6} , respectively. For the beam transport system an overall stability of 5 parts in 10^5 will be sufficient to maintain the beam stability. All the supplies have to be scaled using a single reference voltage derived from the high voltage supply for ease of tuning.

BEAM DYNAMICS

Most of the following subsections have sections of their own. In the present section, we comment only on their beam dynamics. For fuller reports, see <http://decu10.triumf.ca:8080/ht/ISAC/>.

Test stand

The ISAC test stand was successfully commissioned. We consider this a convincing demonstration of the soundness of a 'separated function' approach to mass separator design. In such an approach, the optics elements are kept simple; separate multi-polar

elements are used to correct aberrations. The parallel-faced, flat-pole bending magnet produced both second and third order aberrations. These were successfully corrected with electrostatic sextupole and octupole singlets. Though the dipole bending radius was only 0.4 m, we demonstrated a FWHM mass resolution of 7,800. This was of course for a very small transmitted emittance. For the full emittance of 8π mm mrad from the surface source, the resolution was on the order of 1,000. For more details, see the section on ion sources.

Mass separator

The ISAC mass separator optics design has been finalized and reviewed. Recommendations by the review committee centred mainly on the need for gaining a better understanding of the dipole, which we are inheriting from Chalk River. As well, there was a concern that with 19 quadrupoles in the pre-separator/separator section alone, tuning would be tedious. This is attended to by wiring doublets and triplets together, reducing the number of quadrupole 'knobs' to 11.

LEBT

The section of beam line connecting the mass separator to the rest of the low energy beam transport (LEBT) has been designed. It consists of a special 45° electrostatic bend insert, a 4 quad matching section, a standard 90° bend module, and periodic transport modules.

The beam line from the off-line ion source (OLIS) to the RFQ has been built, and as of the end of the year was being commissioned. Additionally, sections have been schematically designed to match LEBT to the TRIUMF neutral atom trap experiment (TRINAT) and the low temperature nuclear orientation experiment (LTNO).

Polarizer

A special section of LEBT is being designed to polarize the radioactive ion beams. Although initially requested for β -NMR experiments, it is of interest also to LTNO and possibly to experiments in the high energy area downstream of the DTL. For this reason, it is being considered as an insertion section in the LEBT. Polarization is achieved using laser light on a *neutral* beam. The optics therefore must consist at least of a quadruplet to match the beam into a gas neutralizer cell, and another quadruplet to match back out of the ionizer cell. Various design configurations have been considered, including a loop to attach at the point that the LEBT emerges from the floor in the experimental area.

ISAC II

We have begun to look at possible extensions to ISAC. There is significant demand for energies beyond the Coulomb barrier (~ 6 MeV per atomic mass unit), and for masses beyond 30.

Peter Ostroumov (a visitor from INR-Troitsk) has put together a scheme which could achieve 6.5 MeV/u for mass up to 240. The design can be considered as the conservative extreme, because it uses no new technology and singly charged ions from the ion source. The higher mass is achieved by using a front-end RFQ of a much lower frequency (11.67 MHz), and putting it on a platform to achieve an injection energy of 480 keV. The input energy is 2 keV/u and the output energy is 12 keV/u. If the ions have mass larger than 60, they are then stripped in a gas stripper to $q/A \geq 1/60$. Ions are then injected into a 23.33 MHz RFQ, extracted at 80 keV/u, injected into a 58.33 MHz IH linac, extracted at 210 keV/u, injected into a 70 MHz IH linac, and extracted at 0.55 MeV/u. At this point they are stripped to $q/A \geq 1/6$ with a carbon foil. This is to be followed successively by 210 MHz and 315 MHz IH linacs to finally reach 6.5 MeV/u.

We believe that besides giving the full mass range, this scheme will also give the highest possible radioactive ion beam intensity. It will also be the most expensive. It is clear that the higher the charge of the ion, the less expensive will be the accelerator. We are therefore presently considering variants which depend upon development of ECR charge boosting devices.

RFQ SYSTEM

RFQ prototype

The operating pressure at full power for the three module test was 8.5×10^{-6} torr. This proved to be too much for the coupling loop rf window which failed after 15 hours of continuous operation. The vacuum was improved by a long, mild, extensive bake out and replacing the end cover vacuum seals with Viton O-rings. This enabled us to reach a base pressure of 5.5×10^{-8} torr and a pressure of 1.1×10^{-6} torr with rf on. As expected, a measurement with the mass spectrometer indicated the highest component to be water vapour. This is a factor of 20 from rf off to rf on, indicating that there is still some outgassing happening due to the high operating temperature of the section of the vacuum tank that did not get copper plated. The copper plating problem has been solved for the accelerator system RFQ tank. However, we were able to run 100 hours continuously at 20 kW, 40 hours continuously at 30 kW and subsequent runs for 17 and 14 hours at 30 kW without a failure of the coupling loop rf window. This gave us confidence in designing a scaled version for the 150 kW rf window required for the accelerator

system RFQ. The 150 kW window is presently being tested to 40 kW (limit of the test amplifier) which will be sufficient for the 7 ring test.

The test facility was also used to design and test a stem tuner which is used to adjust the frequency of each individual ring to obtain a uniform field distribution along the beam axis of the RFQ. The tests showed that water cooling on the stem was required because of the additional heat load from multipactoring.

RFQ accelerator

This year was dedicated to the fabrication and assembly of the RFQ accelerator components and a 150 kW, 35 MHz rf amplifier.

Vacuum tank

Unlike the prototype, the vacuum tank for the RFQ accelerator is square in cross section. The tank is split diagonally by an O-ring flange into two parts, the tank base and the tank lid. In this configuration, the copper plating is easier to do in two parts and it gives full unobstructed access to the RFQ modules for ease of installation and alignment. The tank weighs approximately 12 tons and is constructed of plate steel which was chemically treated (descaled) and surface ground before fabrication. The tank base forms a stable internal platform on which to mount the RFQ components. It is a 1.58 cm (5/8 in.) thick steel plate mounted on three heavy I-beams running the full length of the tank with attached footpads. The back plate is 3.8 cm (1.5 in.) thick and has most of the penetrations for vacuum pumps, vacuum gauges, rf coupling loop and rf diagnostics. The triangular shaped lid is 1.25 cm (1/2 in.) thick reinforced by tubular section ribs and weighs approximately 5 tons. The copper plating is a cyanide bath process but using a different chemical solution than that used to copper plate the prototype tank. Each piece was plated separately using the triangular enclosure as the container for the cyanide bath solution.

The tank arrived in September but not without its problems. The hole pattern in the footpads did not match the hole pattern in the concrete pad, the tapped holes for the accurate mounting of the platens were not drilled parallel and the most serious problem of all, the diagonal flanges on the base and lid were not machined flat which caused the tank base to move when the lid was bolted to it. The first two problems were solved fairly easily. The anchoring of the tank base to the concrete pad was made more robust and epoxy shimmed to try to prevent the base from moving when the lid was attached. Although it improved the situation, it did not eliminate it. Re-machining of the flanges seems to be the final solution.

Ring assembly

First, the base plate, stem, strongback, and electrode support were pre-assembled using jigs and fixtures and doweled in position. The inner and outer rf skin were then fitted to this pre-assembly to complete the ring assembly. At this point all the assemblies were leak checked and water flow tests performed on all the water cooling circuits. The exposed rf surfaces were initially buffed with Scotch-brite and then buffed with Brasso. The ring was then completely disassembled and all rf mating surfaces were buffed with Scotch-brite and Brasso. The components were then ultrasonically cleaned and re-assembled. The assembled rings were then installed in a precise jig and fixture and a final high precision EDM (electrical discharge machining) operation was used to machine the electrode mounting faces on the electrode supports relative to the ring base plate within an accuracy envelope of 0.0004 in. The individual ring assemblies were then mounted on a platen surface which was machine ground to an equal accuracy. The orientation and positioning of the ring bases were established through precision machining of reference data on the platen and base plate.

Alignment of electrodes

The quadrature alignment of the electrodes to ± 0.003 in., which will be mounted on the high precision machined EDM surfaces of the electrode support, is based on the premise of aligning the relative position of the rings on the platens to ± 0.001 in. Four alignment monuments were fabricated using the same jigs and fixtures that were used to assemble the ring components and machine the electrode support mounting surfaces. Two monuments were mounted on each platen in the same position as the rings would be mounted.

We were able to borrow 2 theodolites from SLAC and with the help of the Department of Geomatics at the University of Alberta we were able to use the line intersection method to align the relative position of the four monuments on the first two platens to ± 0.001 in.

The first 7 ring assemblies were positioned on the platens and the test electrodes (no modulation) were installed. Targets were mounted on the back edge of the electrodes and the relative alignment checked. A picture of the 7 rings and test electrodes installed in the tank is shown in Fig. 110.

RF amplifier

With the successful operation of the 40 kW rf amplifier for the test facility a 150 kW amplifier was designed and built at TRIUMF for the 19 ring RFQ accelerator system. The amplifier and its associated equipment was installed on the mezzanine above the RFQ accelerator in the ISAC building ready for tests into a resistive load.

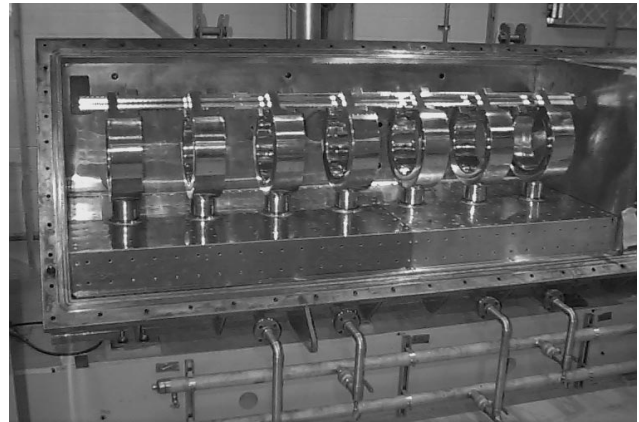

Fig. 110. The first 7 RFQ rings and test electrodes installed in the vacuum tank.

RFQ TASK FORCE

The RFQ task force was established in 1996 with the following goals:

- design, build and commission the off-line ion source (OLIS), low energy beam transport (LEBT) section and pre-buncher to provide an injector of stable beams for the RFQ
- design and build a shortened version of the RFQ for rf and beam tests, in particular to establish the operating frequency, test operation at full power, and measure the acceptance and matching conditions well in advance of the final commissioning schedule
- design and build a diagnostic station downstream of the RFQ to analyze the accelerator performance

Off-line ion source

The off-line ion source (OLIS) is required to commission the LEBT and accelerators as well as supply *analogue* beams to tune the accelerator complex prior to injection with radioactive ions. In addition stable beams from OLIS will be used for both low and high energy experiments. The installation of OLIS was delayed due to a delay in the building construction. In order to minimize the impact on the overall schedule the OLIS installation was begun well before building completion. A plastic tent was built around the OLIS area to protect components from dust. Installation of components began on July 23. Despite the challenging work environment progress was steady. First vacuum was achieved on October 30 and first beam on November 6. The first source installed in OLIS is a microwave (2.45 GHz) CUSP source. The plasma chamber is cylindrical and the rf and beam are injected and extracted

axially. It has been tested in the CRM development area and produces light ions up to mass 40. Eventually this source will be replaced by a new version where the cylindrical plasma chamber acts as resonant cavity with the rf/beam injected/extracted radially. This source is more efficient and is useful to get to higher masses and charge states.

Low energy beam transport

The low energy beam transport (LEBT) installation from OLIS to RFQ proceeded in parallel and by year end beams of both $^{14}\text{N}^+$ and $^{28}\text{N}^+$ have been used to commission the beam line to the last valve before the RFQ. The LEBT proves to be easy to tune and matches well the theoretical tune values.

The RFQ design is unique in that the bunching section is replaced by an external buncher 5.7 m upstream of the RFQ. Up to four harmonics will be used to construct a pseudo-sawtooth velocity modulation on the beam in a single gap. The fundamental buncher frequency was chosen as 11.7 MHz instead of 35 MHz given that the resultant 86 nsec gap between pulses will be important for certain experiments. The buncher plates were fabricated and installed in a standard LEBT box. The pre-buncher was tested using a 300 W wide-band amplifier. Depending on the length of the transmission line and the relative phasing of the harmonics, the circuit was found to have self oscillations. Two problems were identified. Firstly the system was more prone to self oscillate with a large loading capacitance. Furthermore, it was found that the gain of the power amplifier drops off considerably above 35 MHz; as a consequence it was not able to deliver sufficient fourth harmonic voltage to compensate for the reduced bunching efficiency at the higher frequencies. To improve the stability the capacitance of both the vacuum feedthrough and the plates was reduced. In addition the dc voltage of the power amplifier was reduced. However, as a consequence of this action, the maximum power capability of the amplifier was reduced. Tests showed that the system was still prone to self oscillations. Furthermore the required voltage waveform could not be attained due to the power limitations. The 300 W amplifier was replaced with a 1 kW amplifier. The bandwidth limitation still exists, however, so it does not have sufficient drive capability at the fourth harmonic. However, the system is now stable and able to deliver full design voltage for a three harmonic waveform. The lack of a fourth harmonic reduces the calculated RFQ capture efficiency from 81% to 76%. Future solutions to this reduced efficiency may involve adding a wider band amplifier or adding a second buncher in the LEBT. Presently the buncher is bench tested at full power and fully regulated.

The RFQ interim beam test

The final RFQ electrodes will span 7.6 m with 19 modules each consisting of one ring and 40 cm of electrodes. An interim beam test will be done with the first 7 ring section (2.8 m) that will produce an acceleration to 53 keV/u. A schematic of the test set-up is shown in Fig. 111. An rf short will be placed after the seventh module to confine the rf fields. Eight electrostatic quadrupoles are used to transport the beam to a diagnostic station downstream of the RFQ tank. A Faraday cup and profile monitor assembly are placed just after the RFQ short and again in the middle of the electrostatic transport after the fourth quadrupole. The diagnostic station shown in Fig. 111 includes a timing monitor for bunch structure, a Faraday cup, a transverse emittance rig and a spectrometer consisting of an object and image slit and a 90 degree bending magnet.

Beam dynamics studies have been completed in preparation for the beam test. In particular studies have been done to estimate the beam transmission along the electrostatic transport section depending on the initial beam conditions. Figure 112 shows the results for both bunched and unbunched beams and for electrostatic transport quadrupoles on and off. It is expected that for the pre-buncher optimized with 4 harmonics up to 81% of the beam will be accepted while with no buncher the capture efficiency will be 30%. The quadrupoles when tuned will act as an energy filter and the unaccelerated beam will be lost in the first few quads. Therefore the transmission difference between the first Faraday cup and the second will mark the capture efficiency of the RFQ. It is also interesting to note that even with the quadrupoles off some beam will be transported. Measurements will also be done to determine beam energy and energy spread, transverse emittance, bunch structure and transverse acceptance.

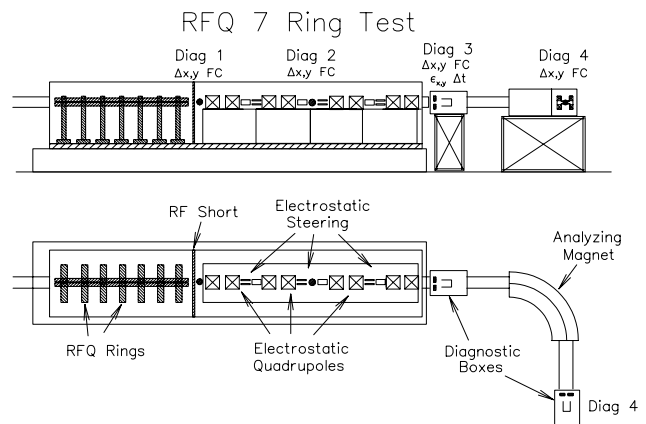

Fig. 111. Schematic diagram of the set-up for RFQ task force beam test.

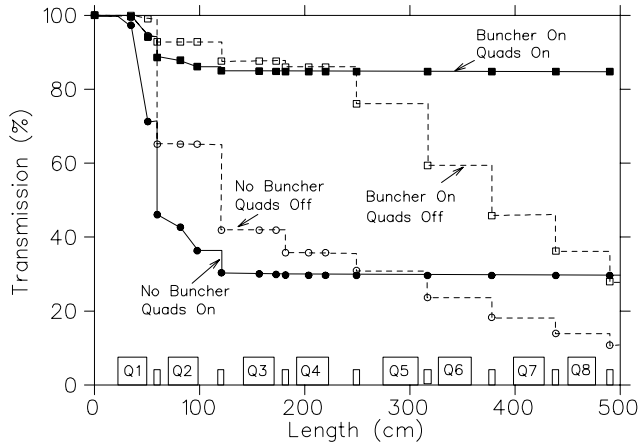

Fig. 112. Beam transmission vs. position down the electrostatic transport for various initial conditions.

MEDIUM ENERGY BEAM TRANSPORT

Further optimizations of the medium energy beam transport (MEBT) have evolved to meet various design issues. A plan view of the existing MEBT design is shown in Fig. 113.

MEBT chopper

The pre-buncher operates at 11.7 MHz, the third sub-harmonic of the RFQ. Beam simulations show that for three harmonics in the bunching field 76% of the beam will be captured and accelerated in the RFQ main rf bucket. Of the remainder $\sim 21\%$ of the beam will be unaccelerated and 1.7% of the beam will be captured and accelerated in each of the two side rf buckets. The unaccelerated beam will be lost on collimators placed between the first few quadrupoles in the

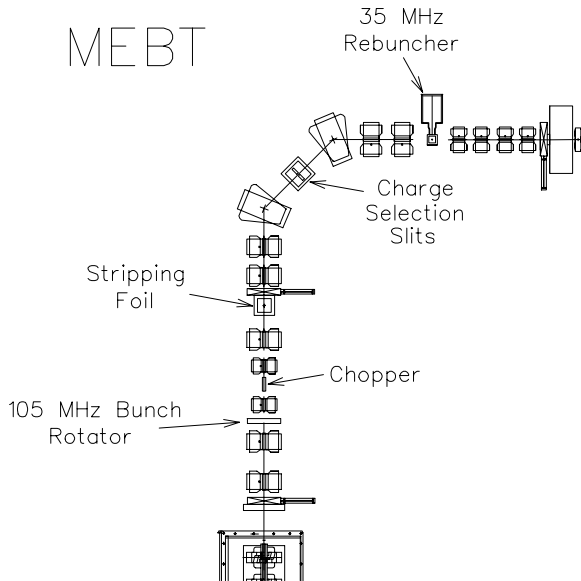

Fig. 113. Schematic view of the existing MEBT design.

MEBT. The collimators will be shielded and designed to be removable.

An rf chopper insertion has been designed for the MEBT. It will remove the two side-buckets contaminating the 86 ns between the main beam pulses. The insertion is positioned in the matching section between RFQ and stripping foil. A position downstream of the stripping foil would reduce the required chopper field but there is no room available. The matching section of MEBT was originally designed with four quadrupoles to provide a double waist at the foil and a 105 MHz buncher to give a time waist. To insert the chopper in the matching section we split the third quadrupole into two smaller quads with the chopper in between. The horizontal optics are optimized to get a parallel beam in the drift with a large horizontal spot size (small divergence) to minimize the required chopper deflection. The chopper slits would be placed just upstream of the foil at the horizontal waist. This gives a parallel to point optical layout in the horizontal plane from chopper to slit. The three-dimensional beam envelopes and ellipses for the matching/chopping section are shown in Fig. 114.

Charge selection section

The QQDQQDQQ charge selection section from stripping foil to rebuncher was also optimized. The rebuncher design specification was changed from 23 MHz to 35 MHz to simplify the design of the cavity. Consequently it was necessary to reduce the length of the section to reduce the amount of debunching at the rebuncher. The quadrupole length specifications were reduced and the two small quadrupoles in between the 45° dipoles were removed from the design. Tunes for various dipole entrance and exit angles were

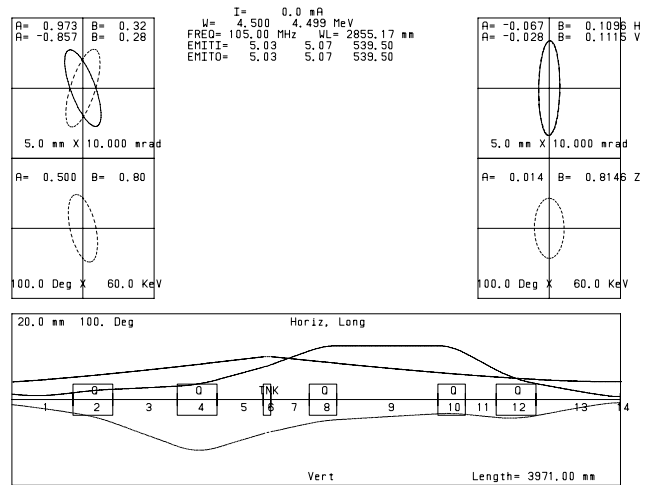

Fig. 114. Beam envelopes and ellipses for the matching/chopping section of MEBT.

calculated. In the end a rectangular pole dipole was chosen with entrance and exit angles of 22.5° . This magnet is slightly larger than a competing wedge design but the simplicity of construction was thought sufficient reason to choose this design.

MEBT rebuncher

Two designs for the 35 MHz rebuncher have been considered. The first, a folded $\lambda/4$ structure was developed in a collaboration with LBNL. A second design based on a single spiral support inside a pillbox cavity has been studied in a full-scale model. The spiral resonator is presently favoured due to its lower cost. Future work will involve MAFIA and mechanical studies to establish a stable design for the resonator.

DRIFT TUBE LINAC

The ISAC separated function drift tube linac (DTL) is specified to accelerate radioactive ions of charge to mass $1/6 \leq q/A \leq 1/3$ from $E = 0.15$ MeV/u to a final energy fully variable up to 1.5 MeV/u. Five independent H-mode (IH) structures operating at 105 MHz and 0° phase provide the acceleration. Quadrupole triplets are positioned between IH tanks to provide transverse focusing. Three gap resonating cavities positioned downstream of the quadrupoles provide the longitudinal focusing. Diagnostic boxes are placed between the bunchers and the IH tanks.

Last year we determined the basic specifications of the DTL elements. This year we concentrated on studying the details of the variable energy operation, and defining in more detail the geometry of the IH structures and the intertank spaces. In particular the detail design of tank 1 and buncher 1 were completed. In addition a concept design for the intertank space was determined and the design of the quadrupole triplets was initiated. The commissioning strategy was also discussed in an effort to plan the development of diagnos-

tic devices and to determine the design of the diagnostic boxes.

Beam dynamics and specifications

The code LANA has been used to study the beam dynamics and to set the general specifications for the tanks. MAFIA has been used to model the rf characteristics. The strong periodic focusing yields small beam sizes and increased acceptance. The longitudinal and transverse acceptance are 4.8π keV/u-ns and $0.6 \pi \mu\text{m}$ respectively.

The gross specifications of the five IH tanks and the three split-ring resonators for the design particle of $q/A = 1/6$ are given in Table XI. The quantity of cells in each tank is chosen to satisfy both transverse beam size requirements and debunching constraints in variable energy mode. Tank apertures are chosen to give sufficient transverse acceptance while maintaining a gap-to-aperture ratio of at least 1.2 for efficient acceleration. Each triplet unit has an effective length of 33.5 cm, with a bore aperture of 24 mm and a maximum gradient of 64 T/m. They will occupy a 43.5 cm space between tanks.

Maximum accelerating gradients are determined by restricting the total power per unit length to less than 20 kW/m based on shunt impedance calculations with MAFIA. The drift tube aperture is significantly larger (see Table XI) in tanks 2–5 than in tank 1. The increased capacity of the larger tubes requires a lower tank radius than that of tank 1 to obtain the desired resonant frequency. Ridge parameters, in particular the ridge base width and ridge length, were varied in MAFIA to alter the inductance for frequency correction. In all cases the drift tube wall thickness is 5 mm. This results in a reasonably conservative peak surface field in the last tanks of 14 MV/m.

To achieve a reduced final energy, the higher energy IH tanks are turned off sequentially and the

Table XI. Parameter specifications for each IH tank and buncher (B1-B3) for the design particle of $q/A = 1/6$ in full energy mode. All cavities operate at 105 MHz. Here L is the length, a is the tube aperture, R is the tank radius, $\overline{E_o \cdot T}$ is the effective field gradient, E_s is the peak surface field, Z is the effective shunt impedance and P_ℓ is the power per unit length. The quoted shunt impedance values are from MAFIA. The power/unit length and power calculations assume a shunt impedance 75% of the value quoted.

Tank	No.	L	a	R	$\beta_{\text{out}}(\%)$	$\overline{E_o \cdot T}$	E_s	V_{eff}	Z	P_ℓ	P	E_{out}
-	Cells	(cm)	(mm)	(cm)	$\beta_{\text{in}} = 1.8$	(MV/m)	(MV/m)	(MV)	(M Ω /m)	(kW/m)	(kW)	(MeV/u)
1	9	26	10	46	2.2	2.1	10	0.5	480	12	3.3	0.23
2	13	50	14	38	3.1	2.4	12	1.2	495	16	7.8	0.44
3	15	77	16	38	4.1	2.5	14	2.0	464	18	14	0.78
4	14	90	16	38	5.0	2.4	14	2.2	400	19	17	1.14
5	13	98	16	38	5.6	2.3	14	2.2	365	19	19	1.50
B1	3	10	14	28	2.2	1.9	13	0.19	75		6.5	0.23
B2	3	12	14	28	3.1	2.3	16	0.26	74		11	0.44
B3	3	14	14	28	4.1	2.3	16	0.32	67		15	0.78

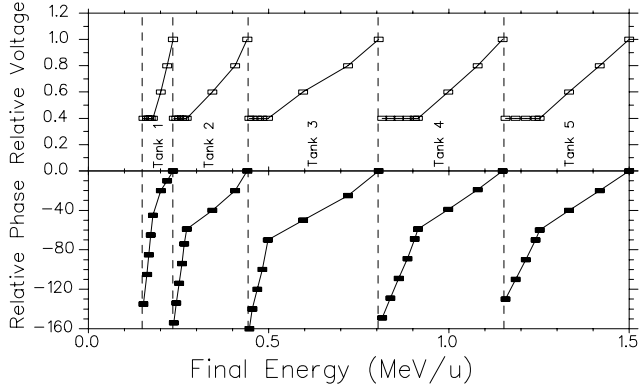

Fig. 115. Tank voltage and phase required for a certain final energy. Upstream tanks are turned off. The full energy case corresponds to tank voltages of 1.0 and phases of 0° .

voltage and phase in the last operating tank is varied. The split-ring resonator cavities are adjusted to maintain longitudinal bunching.

A plot of the tank voltage and phase required for a given final energy is shown in Fig. 115. Each point represents a tune that has been simulated. In all the cases for input beams of $1.6 \pi \text{keV/u-ns}$ the final emittance was $\epsilon_z \leq 1.7 \pi \text{keV/u-ns}$. For a reduced voltage the particle bunch is phased negatively with respect to the synchronous phase so that as the particles lose step with the synchronous particle and drift to more positive phases they gain the required energy. Below some minimum voltage (set by multipactoring criterion) the phase alone is used to fine tune the output energy. For the lower energies the upstream buncher is used to match the beam to the de-tuned tank. The buncher following this tank is then used to capture the diverging beam. The three gap split-ring structure is chosen for its large velocity acceptance and large multipactor-free voltage range. The three bunchers must operate over β regimes given by $1.8\% \rightarrow 2.2\%$, $1.8\% \rightarrow 3.1\%$, $1.8\% \rightarrow 4.1\%$ respectively and over voltage ranges from 15% to the tabulated value. Three resonators with gap structures synchronized to beam velocities of $\beta = 2.3\%$, 2.7% and 3.3% have been specified.

In Fig. 116 we show the initial and final position of a grid of particles in longitudinal phase space after acceleration in tank 1 for two different tank voltages, $V = 0.4$ and 0.8 . Distortion of phase space occurs for phases greater than that of the maximum energy gain. Below this the energy gain falls off nearly linearly. The diagram is useful in choosing the proper matching conditions entering the de-tuned cavity to reduce emittance growth during acceleration and to minimize phase spread in the next debunching cavity.

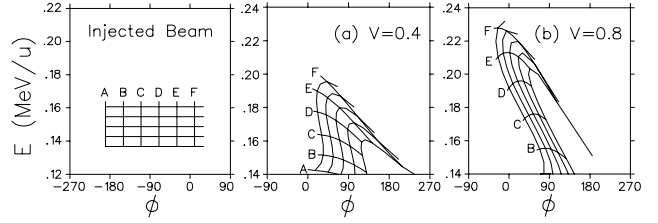

Fig. 116. Final positions in $E - \phi$ space of initial grid of particles after acceleration through tank 1 for voltages of 40% and 80% of the full energy setting.

Tank 1 investigations

In order to finalize the specifications of tank 1 before detail design, detailed beam dynamics and rf modelling studies were completed. The beam dynamics study involved incorporating three-dimensional, *realistic*, MAFIA generated fields in LANA, for a more accurate beam dynamics simulation. MAFIA was also used to optimize the tank geometry.

In an IH structure the capacitance is concentrated in the drift tubes. Hence as the cell length increases with β along the tank, with corresponding decrease in capacitance, the field profile will be asymmetric, higher at the first half of the cavity and falling off towards the end plates. This leads to an uneven power distribution in the stems and a non-uniformity in the peak surface field on the tubes. In the case of tank 1 the small length results in extra capacitance between the end plates and the ridge support. Shifting the ridge support to an asymmetric position improves the asymmetry at the expense of the shunt impedance. By varying the gap to cell length ratio, g/ℓ (Fig. 117(a)) the field profile on axis can be flattened (Fig. 117(b)). Note that although the g/ℓ variation changes the distribution of the field in a cell there is no substantial change in the distribution of the average field along the tank. However, the peak surface field in each cell is made more uniform as is the power loss per stem. In flattening the maximum accelerating field the peak surface field variation in tank 1 is reduced from 18% to 5%.

The specifications and initial beam simulations of the DTL were calculated using a square field approximation in LANA. For tank 1, these calculations were repeated with three-dimensional fields output from MAFIA to check the analytic gap-focusing calculation in the square wave model and to calculate accurately the effect of the E_y field on axis (dipole component) caused by the IH stem structure. A comparison of the transverse and longitudinal calculations using both the square wave model and the realistic field simulations compared very closely.

The dipole component plus the effective integrated voltage from the field is plotted in Fig. 117(c). This field produces a maximum deflection of 0.6 mrad with

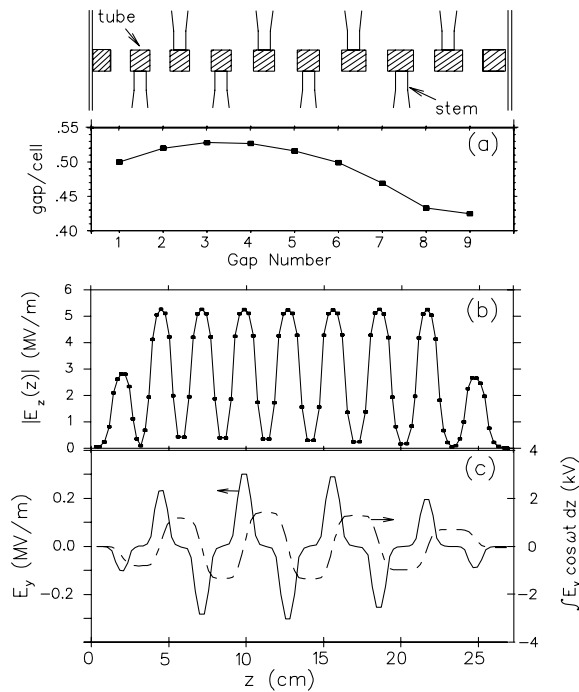

Fig. 117. Tank 1 longitudinal (b) and vertical (c) field profiles from MAFIA for the gap to cell length ratio shown in (a).

a maximum shift in beam centroid of $12 \mu\text{m}$. The cumulative deflection is negligible due to the alternating nature of the kick. Nevertheless some steering will be incorporated into the quadrupoles to allow for fine tuning of the beam position.

The first IH tank (tank 1) will be fabricated on an accelerated schedule as a working prototype for the other IH tanks. The detail design is completed (Fig. 118). The tank and ridge are fabricated from mild steel. Cooling channels will be drilled in the ridge and hollow copper cooling inserts will be fit on the end plate

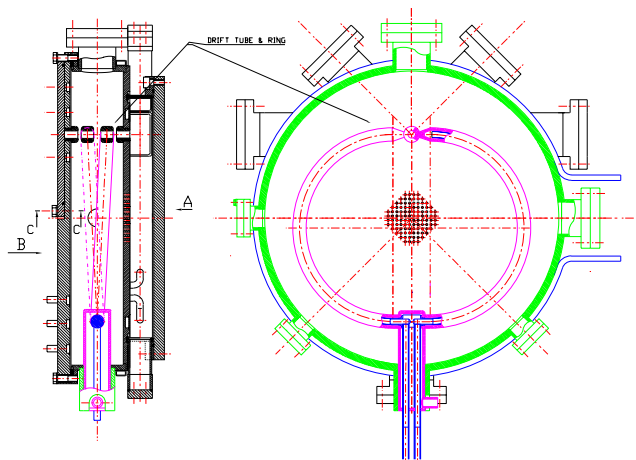

Fig. 118. Assembly drawing of DTL tank 1.

in the vicinity of the beam entrance and ridge end. Stems are fabricated from copper and cooled through two holes drilled from stem base to near the drift tube. Water is supplied through a separate cooling circuit drilled into the ridge. The interior of the tank is to be copper plated with a bright acid finish to a thickness of 0.25 mm. Tuning is done through a capacitive plate with a servo-drive controlled via an rf pick-up loop.

DTL buncher

The first DTL buncher ($\beta = 0.023$) has been designed and is being fabricated at the Institute for Nuclear Research in Troitsk, Russia. Both two gap spiral bunchers and three gap split-ring bunchers were studied. It was found that even when accounting for the reduced velocity acceptance as the number of gaps increases the power consumption rules out the two-gap solution. For instance in the case of the third buncher the spiral option would require 29 kW as opposed to 11 kW in the case of the split-ring option.

The first split-ring buncher is shown in Fig. 119. The tank diameter is 55 cm, tank length is 9.8 cm, ring diameter is 35 cm and ring tube diameter is 3 cm. The ring tube is hollow to allow forced water cooling of the ring and drift tube. The water comes to within 30 mm of the drift tube. MAFIA calculations indicate that 60% of the power is dissipated in the supporting ring with 30% in the end walls. The buncher will be brazed to the downstream diagnostic box due to the limited room available in the inter-tank space. Five diagnostic ports each $1.5 \text{ cm} \times 3.0 \text{ cm}$ will be made available on the box. The conceptual design of the inter-tank connections has been worked out. A drawing of the inter-tank space is shown in Fig. 120.

DTL commissioning

A summer workshop on the DTL produced some development on the DTL commissioning strategy. Two methods were discussed. In the first method the whole

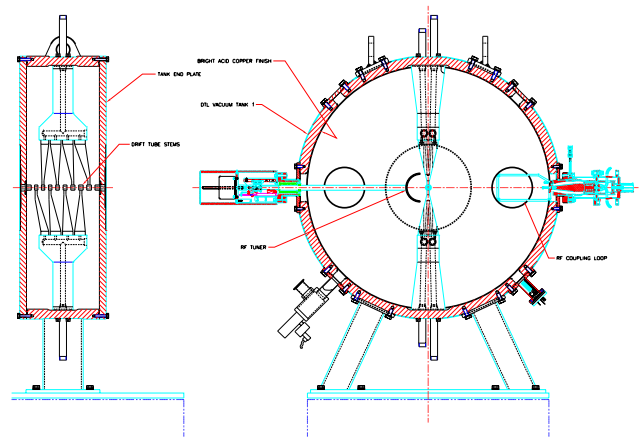

Fig. 119. The DTL buncher, side and end views. The side view shows the attached diagnostic box.

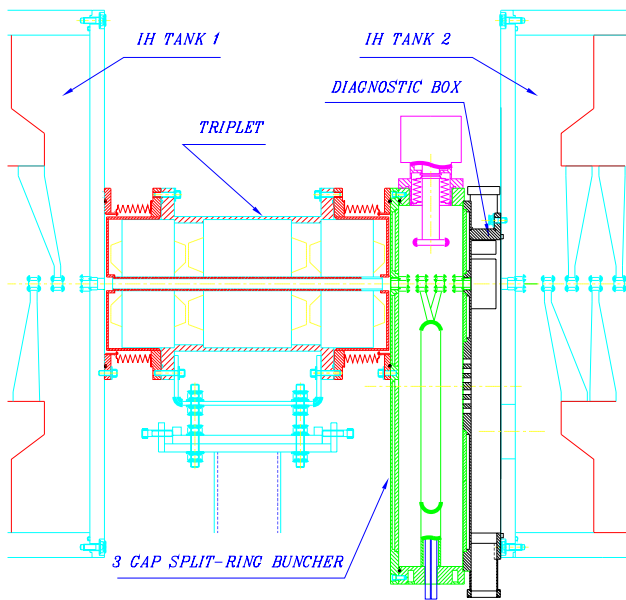

Fig. 120. The conceptual design of the DTL inter-tank connections.

DTL or perhaps a major section is put together as a unit and is commissioned with beam as a unit. The commissioning diagnostics are placed in the diagnostic boxes between rebuncher and tank and a separate diagnostic station is placed downstream of the linac. The diagnostics between tanks consist of an $x - y$ profile monitor for transverse tuning, a phase probe for relative energy measurements and FFC or other timing device for bunch length measurements. The downstream diagnostic station will include an emittance rig and a 90° analyzing magnet. A 35 MHz rebuncher may be available between DTL and analyzing magnet to allow a longitudinal emittance measurement. The standard techniques for measuring relative energy will be to measure the relative phase between two pick-ups in two neighbouring diagnostic boxes. Any change in the relative phase is indicative of a beam velocity change. The rebunchers are optimized with the bunch length detectors, from velocity measurements and from comparison with simulation.

In the second method the IH tanks will be installed as they arrive. A diagnostic box will be placed after the tank to be commissioned. Upstream triplets and bunchers will be installed but downstream quads and bunchers are replaced by the large diagnostic box. Two resonant pick-ups are placed in the diagnostic box a distance D apart. The pick-ups are non-intercepting and are followed by a fast Faraday cup for bunch length measurement. A transverse emittance rig can be placed between the two pick-ups. One of the pick-ups could be made moveable on a precision slide to allow absolute energy measurement.

A non-intercepting phase probe was designed as part of these discussions. The probe consists of a capacitive pick-up and resonant circuit tuned to the fourth harmonic of the bunch frequency (47 MHz).

HIGH ENERGY BEAM TRANSPORT

The initial design concept for the high energy beam transport (HEBT) has evolved in 1997 with the demands of the experimenters and the budget. A schematic of one of the HEBT designs is shown in Fig. 104.

The key experimental facility in the ISAC high energy area will be the DRAGON recoil product spectrometer. Other experimental areas considered for this area were the ^7Be experiment, a materials science section, a multi-purpose area and a scattering chamber. It was decided to feed these various areas from a single take-off point as opposed to two take-off points as in previous designs. The single take-off was moved away from the DTL in order to keep room available for future expansion of the accelerator to higher energies. Immediately following the DTL there is a 5Q 3.5 m matching and chopping section. The beam is focused to a double waist at the first rebuncher section. This is followed by an 8 m periodic section, a second rebuncher and then the achromatic bend section to the various areas. The 8 m periodic section will include a 90° spectrometer for independent monitoring of the DTL during tuning. Originally the footprint of the DRAGON facility was such that two 22.5° bends were specified; later this was changed to two 30° bends. In both schemes the second magnet was specified as a large switching magnet to bend the beams to a final two magnet bend angle of 105° , $45^\circ(60^\circ)$, and 5.5° . In all cases the bends were singly achromatic. A rebuncher was placed in each of the three lines to provide time focus on the target. Beam envelopes for the matching/chopping and periodic section as well as for the 45° take-off to the DRAGON are shown in Figs. 121 and 122.

BEAM DIAGNOSTICS

During 1997 the instrumentation installed in the ISAC ion source test stand was commissioned, the properties of the 492 MeV proton beam extracted through the 2A exit horn were measured, and designs for the diagnostic equipment for the beam line, BL2A, which delivers these protons to the ISAC production target were completed; installation of this beam line has started. Much of the diagnostic instrumentation for the low energy, <60 keV, heavy ion beams has been designed and the rest is under design, this includes devices in the exit modules, separators and LEBT. Those devices installed in a beam line between the off-line

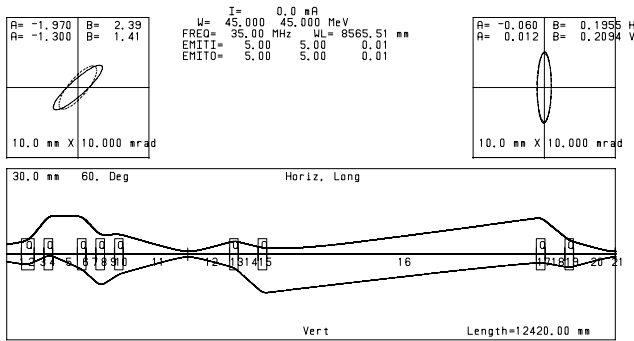

Fig. 121. Beam envelopes for the HEBT matching/chopping and periodic section.

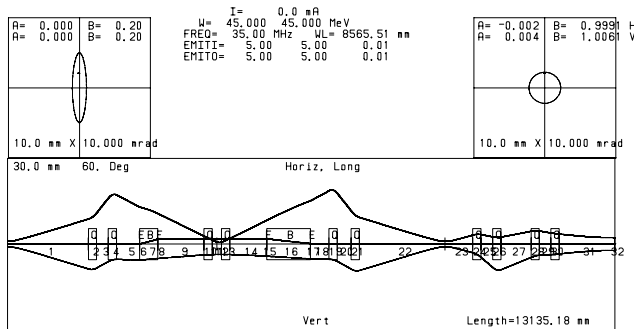

Fig. 122. Beam envelopes for the 45° achromatic bend and matching section to the DRAGON target.

ion source and the RFQ were tested with beam toward the end of the year.

Ion source test stand

The profile monitors developed by the ISIS group pass a tungsten wire through the beam. An 0.5 Hz motor rotates a wheel; a rod freely attached to the circumference of the wheel connects with one end of an arm passing, via a bellows, into the beam line vacuum. This arm is pivoted about a point between the rod connection and the edge of the beam space; a 0.5 mm diameter tungsten wire projects from this end of the arm through the beam space. Operation of the motor causes the wire to rock back and forth through the beam twice each 2 second cycle. One end of a linear potentiometer is attached to the rod-arm junction to give its position. The current intercepted by the wire is amplified and displayed against the potentiometer reading to yield the beam profile. The motion is not linear since the arm is suspended from a fixed pivot but corrections are small for beams of small diameter on centre. The device has been satisfactory for beams with typical diameter ~ 1 cm but some concern was felt that vibrations of the wire might affect the resolution required for smaller beams.

The frequencies of the first three modes of vibration were calculated assuming that the wire could be

modeled as a rod clamped at one end. The frequency of the fundamental mode was also measured using a sample arm and wire. The fundamental was the dominant mode and while its measured frequency was $\sim 10\%$ lower than that calculated it showed the expected dependence on the reciprocal of the wire length squared. The next mode had a much smaller amplitude and faster damping time. The amount of energy transmitted to the wire during operation was measured by attaching an accelerometer to the arm of a profile monitor; it was not possible to attach to the wire. The power spectrum showed a strong narrow peak at 34 Hz, thought to originate from the motor and gearing, and lesser, broader, peaks around 52 and 60 Hz. These induce vibrations in wires 100 mm and 75 to 80 mm long.

A simple device was built to measure the reproducibility of the actual wire position compared with that given by the potentiometer. Light from a 2.5 mW laser diode was transmitted 0.27 m to a pinhole 0.2 mm diameter in a foil covering the entrance to a light pipe connected to a phototransistor used as a detector. The plane of wire motion was close to the pinhole and since the wire diameter exceeded that of the pinhole the light was interrupted completely during passage. The cutoff and restoration of the detector signal were linear and the midpoint of the cutoff was used to trigger an oscilloscope displaying the potentiometer voltage. Data were recorded for 50 cycles of continuous operation and 50 cycles of a single pass and return each followed by a resting, damping, interval. The width of the band of potentiometer voltages at the trigger point was proportional to the jitter in wire arrival time, i.e. to the amplitude of wire vibration. It was found that, on average, the position reproduced to within 0.5 mm, shorter wires and single scans followed by a resting time were more reproducible than continuous cycling. The two modes for operation differed most strongly for wire lengths of 108 mm, 125 mm, and 75 to 90 mm. The first and last correspond to the frequencies seen by the accelerometer when attached to the arm. The resolution of this simple apparatus is < 0.1 mm and it is planned to employ similar equipment to check out other monitors.

The profiles measured on the ion source test stand using the monitors showed an unusual amount of noise on the final digital signal indicating position. This noise was ≥ 0.1 V and equivalent to $\pm 1-2$ mm in position. A number of factors, both digital and analogue, contributed to this. The ADC used was a Joerger 32A with 32 input channels shared between amplified current signals from the wire, position potentiometer readings and signals from other systems. It was found the channels were not perfectly isolated and that cross talk

could occur between channels. In addition this particular module showed jumps in the digital output equivalent to $\cong 80$ mV ($2^4 \times 4.9$ mV (base unit)) as the voltage input changed slowly and smoothly. This model of ADC is susceptible also to open input channels, however, all 32 were in use on the test stand. Less noise is seen on the profile monitors on the proton beam lines; these have the signal and position recorded by a local digitizer which is then read by the control system after completion of the scan. This more expensive system may be adopted in ISAC where conditions warrant.

In general the electrical environment in the vicinity of the test stand is noisier than usual. It had proven difficult to provide a high quality ground at this location and ± 0.5 V ringing at 8.5 MHz was seen on the racks and crates. Some of this came from the power supply of the PLC used for the control system. The profile monitors had been installed with single conductor cable which meant that ground loops existed between the potentiometer and its supply and from the wiper readback. Coaxial cable was replaced with twinax so that the signal processed was the difference between the signal wire and its twin grounded at the amplifier but floating at the potentiometer end. In addition buffer amplifiers were installed at the potentiometer.

No noise was introduced from either the conductive plastic potentiometer or the motor, apart from a 5 mV jump on one potentiometer some distance from the point of measurement. The local linearity of the potentiometer was very good with deviations < 11 μ V. Future monitors may incorporate a shorter potentiometer in order to make use of a greater fraction of the voltage supplied.

A simple harp monitor constructed from 0.005 in. gold plated molybdenum wires soldered to Veroboard frames was installed near one of the test stand multipoles. It was found that centering the beam on this monitor greatly simplified the problem of correcting aberrations.

General activities

During the year estimates were made of the electrical services (cables, cable trays and rack space) required for the beam diagnostic equipment associated with BL2A, the 53 keV test of the 7 module RFQ, and sections from the exit modules through the separator to LEBT. Most of the cables were installed for the vault section of BL2A and for the RFQ test.

Pre-amplifiers to operate at relatively low bandwidth have been constructed at INR-Troitsk and by the Detectors group at TRIUMF. They are intended to be used with quasi-dc beams or with slowly moving monitors or sweep magnets. The first versions have been assembled in metal Hammond boxes and are operated in air. The version at INR uses OPA128 Op-

Amps and switches over 6 decades of range. The most sensitive range produces 1V/10 pA with ~ 1 mV drift. The TRIUMF version, which incorporates an AD549, has been used in conjunction with ion beams on the test stands. The most sensitive range is 10mV/pA, the drift is about 0.3 mV in 8 hours and the resolution is about 0.5 pA. When used on the CRM test stand the preamplifier picked up 7 pA of 1 kHz noise from a nearby turbo-pump. The pump was turned off for the final measurement where the electronic noise was less than 0.2 pA. A 1 kHz low pass filter will be installed in the next prototype together with switches to give gain ranging. The signal rise time was < 12 ms so that data acquisition was 50 times faster than when using a Keithley meter at the same sensitivity. The immediate applications will be for measurements of ion beam energy spread and for the TRINAT experiment. Applications on ISAC will appear after the initial commissioning. In the future, lighter models which operate in vacuum may be attached close to the head of an instrument.

Beam instrumentation for low energy heavy ion beams

Design is almost complete for the diagnostic devices in the exit modules and the focal planes of the pre-separator and separator. These consist of harp profile monitors, Faraday cups, and slits. The devices at the pre-separator and upstream will have to be able to be removed quickly and eventually remotely since this region will accumulate the largest amount of induced radioactivity and contamination. The slits at the pre-separator focus have an adjustable gap and are mounted, together with a Faraday cup, on a plate that can scan across the beam. The slits at the pre-separator are adjustable in width and are followed by a rig to measure the emittance in the plane of dispersion (horizontal). The diagnostics in the transport sections of this region will be copies of devices that have worked on ISIS and the test stand.

A special profile monitor has been designed for operation in the RFQ tank 11.5 mm upstream of the vanes. The beam spot is expected to be less than 3 mm diameter at this point and the tolerance on beam alignment with respect to the axis of the RFQ is 0.1 mm. The monitor head is moved by a stepping motor over a total range of 35 mm with a precision better than 0.1 mm. The head carries two wires to yield profiles projected in the X and Y planes and one wire bisecting the first two to give the sense of any large correlations. This head could be replaced by one carrying a slotted plate backed by a shallow Faraday cup should the current of some beams be very low. Measurements will only be made when the RFQ voltage is off and the

entire mechanism will be withdrawn from the vacuum tank when the RFQ is operating in order to protect the electronics from rf pickup and to avoid perturbing the rf fields in the tank. The drawings for production have been completed and parts ordered; it is expected to start assembly in the spring.

The commissioning of the 7 sector RFQ requires measurements of the longitudinal distribution of the beam at points between the buncher and the RFQ and after the RFQ. It was determined that the best resolution at low currents and energies would be provided by a microchannel plate registering electrons produced when the ions hit a wire. A suitable microchannel plate assembly has been ordered and should be installed during the spring of 1998. Prior to this we will make some measurements using a fully intercepting fast Faraday cup donated by INFN-Legnaro.

To achieve the optimum counting rate in the longitudinal monitor discussed above we wish to spread secondary electrons over the surface of the channel plate without broadening the spread in flight times from the wire. A code has been written to track electrons through an electrostatic field that may be derived from a combination of analytic fields and fields from relaxation codes. It showed that the proposed geometry and bias potentials should not worsen the resolution by more than 40 ps. The code is in satisfactory agreement with one obtained from the instrumentation group of INR-Troitsk. The code has also been used to ascertain the susceptibility to magnetic fields; transverse fields should be kept <1 G. This application is fairly simple but systems based on secondary electrons are used to measure longitudinal distributions with picosecond resolution and to measure correlated longitudinal and transverse emittance. These applications require that the electrons be brought to a focus and such a tracking code will be essential.

It may be necessary to reduce the beam current for certain types of measurement, for example those involving saturable devices such as channel plates or silicon detectors or for experiments that wish to check the effects of space charge. The ion source tune could be altered to reduce the current but this may also alter beam quality, e.g. emittance. It is more usual to insert metal meshes and we use stainless steel mesh with a pitch of 0.64 mm and a transmission of 37% per sheet. At some locations we can have well focused spots of a small emittance beam that are only 1 or 2 mm wide and such meshes may give a reduced beam made up of very few pixels. It was decided to investigate the use of polycarbonate micropore filters for this purpose. These may be purchased with pore diameters from $\ll 0.01 \mu$ to 14μ and (random) pixel spacings from 0.05 mm to $\ll 0.02$ mm. Experiments with a 27 keV O^+ beam on

the ion source test stand showed the expected reduction factors. These ranged from 7% for a foil with 14μ pores through 0.3% for 3μ to 0.025% for two 8μ pore foils in series. The foils were sandwiched between two steel meshes and were undamaged after several hours provided the current density is <0.1 A/mm². It is suspected that damage at higher current densities is due to sparking and that a thin sputtered conducting layer should permit operation at higher current densities if wanted.

A version of the CERN-ISOLDE beam observation unit, which consists of a combination of a scanning blade profile monitor and a Faraday cup, is being produced by Danfysik Inc. and a model was purchased for evaluation at TRIUMF. The Controls group has been able to operate the linear scanning mechanism with accelerations up to 1500 mm/s/s and linear speeds of 900 mm/s without any apparent "walk" away from a limit switch. The next step is to make measurements of the outgassing rate and of the jitter on blade position.

Visitors

A workshop on diagnostic techniques for radioactive ion beams (RIB) was held at TRIUMF in May. This was attended by 15 people from other laboratories and over 20 TRIUMF personnel. The overhead transparencies used by the speakers were photocopied and distributed to participants; some spare sets are still available.

Other visitors to the diagnostics team included Erich Kugler from CERN-ISOLDE who gave valuable advice based on over 20 years practical experience with RIB, Luigi Rezzonico from PSI who designed beam position sensors for BL2A and helped to de-bug the profile monitor system used on the ion source test stand, Andrey Novikov from INR-Troitsk who designed some prototype pre-amplifiers, and Mark Matthews a summer student from the University of Saskatchewan who worked with Luigi Rezzonico on the test stand problems and also developed the method to measure the reproducibility of the position of a sense wire during repeated scans. All visitors wrote reports or design notes.

ISAC CONTROLS

During the previous year, the ion source test stand was used as a test-bed for the EPICS control system tool-kit. Based on this experience, it was decided to use EPICS for the implementation of the ISAC control system. The main advantages of this approach are

- Sharing of resources in a collaboration of accelerator controls groups
- Reduced software effort
- Increased flexibility and functionality of the control system

- Increased software quality.

In addition, the use of a “standard” control system will also facilitate future expansions of the ISAC machine in collaboration with other laboratories.

During the second quarter, a skeleton project team for implementation of the ISAC control system was formed from members of the Electronics Development group. In July, 1.5 members of the Central Controls group and 0.5 members of the Electronics Services group joined the team.

Also during the second quarter, the conceptual design of the control system was finished. Following the EPICS model, the ISAC control system will consist of a flat topology of boot and application servers, operator interface stations, and input/output controllers (IOCs) which are distributed on one or more Ethernet segments. For the boot and application servers, SUN UNIX workstations were chosen. Although not widely used on site up to now, SUN stations were given preference because of the excellent support within the EPICS collaboration. Pentium based PCs will be used as operator interface stations and will run both X-server software and native PC applications. For IOCs, VME-based CPUs (initially Motorola MVME162) will be used running the VxWorks real-time operating system.

The I/O hardware which is controlled by the IOCs will be organized in three different sub-systems:

- A Modicon PLC system controlling the vacuum system providing industry-standard I/O, high up-time and easily verifiable interlocks
- A system of TRIUMF designed power supply controllers, distributed on CAN-bus providing a very cost effective way of controlling the beam optics devices
- VME I/O modules for direct control and tight integration of the beam diagnostics devices with the IOC CPU.

The experience gained with EPICS and the Modicon PLC on the ISAC test stand control system during the previous year was reviewed. Standards for PLC programming, EPICS data base development, and operator interface design were improved and updated. Detailed design and implementation was started in June for the off-line ion source (OLIS) and the low energy beam transport (LEBT) section from OLIS to the RFQ.

Hardware

PLC drops and breakout cabinets were detailed, built, and pre-wired during the summer. After testing

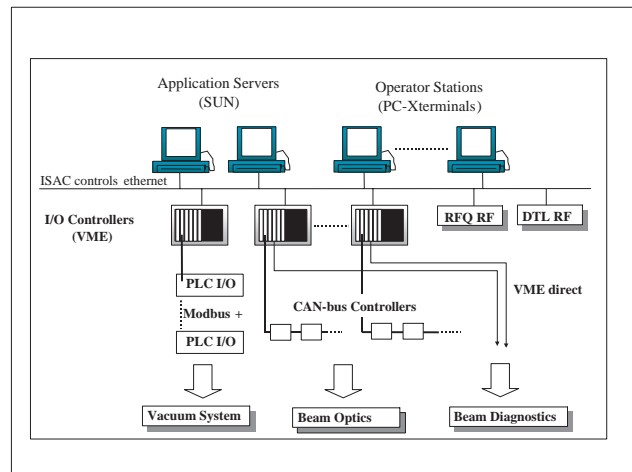

Fig. 123. Control system.

they were installed in the ISAC experimental hall in September. A breakout cabinet for servicing the OLIS and LEBT diagnostics was installed in November. Device connections were made as devices became available. The production version of the CAN-bus based power supply controllers was developed (see details in the Electronics Development section). One CAN-bus loop with 85 power supply controllers was installed to control all beam optics elements. Due to the rudimentary state of the ISAC experimental hall and services, temporary set-ups for the PLC, the control console in the LEBT area, and the connection to the site Ethernet were used.

Software

The PLC was programmed in ladder logic, using Modicon’s MODSOFT programming tool. For ease of program state visualization in on-line mode, the program was implemented as segments of linear ladder logic and no subroutine programming was used. A simple hand-shake and watchdog protocol was implemented to ensure safe startup and synchronization between the PLC and EPICS. The PLC program can be switched between simulation mode and run mode by the supervisory system. This is achieved by using intermediate variables instead of hardware input or output values in the ladder logic. In run mode, the hardware I/O space is mapped to these variables before executing one ladder scan cycle. In simulation mode, this hardware mapping is replaced by the execution of a simulation code segment, which mimics real device behaviour.

The EPICS software effort went mainly into new device/driver support, IOC programming by configuring the EPICS function block data base, and operator interface design using EPICS tools at the UNIX level.

Device/driver support

The support for the Modicon PLC which was developed for the test stand was improved to better conform to EPICS standards. CAN-bus support was obtained through the collaboration from Royal Greenwich Observatory in Cambridge and could be used out of the box. Some of the new VME modules used for the beam diagnostics system needed an adaptation of existing EPICS device support software modules. In order to make interfacing of different VME modules transparent to the EPICS record support, a generic VME device support layer was written. Stepper motor support for the OMS58 eight-axis motor controller was obtained from the collaboration and tested.

IOC programming

Starting from the Capfast schematics of the ISAC test stand function block data base, emphasis was placed on developing re-usable component schematics. These components make it easier to maintain the code and develop support for new devices. Emittance rig support was converted to use the EPICS motor record

and VME I/O. The subroutine record supporting the ISIS type wire scanners was improved and adapted to VME I/O.

Operator interface

Screens for vacuum system, beam optics/diagnostics, interlock bypassing and device diagnostics were developed, following a hierarchy of “ISAC overview” → “sub-system” → “device”. Parameter save/restore and simple mass-scan functionality were provided using standard EPICS tools. A sequencing tool which was developed for the control systems of the Ebco TR30 and TR13 cyclotrons was converted to the EPICS environment as UNIX command line and MOTIF versions as well as a native PC version.

Commissioning

Due to the tight schedule, the control system was commissioned “device by device” as the different sections were installed. The OLIS system was commissioned in October and early November, the first section of LEBT in December.